

QUICK CHANGE TWEEZERS' HANDLES are Available in the Following Materials
See on pages 4-5, and 77-79 for Handles' Part Numbers and sizes

Suffix	Materials	Example
...-SA	Stainless Antiacid-Antimagnetic Steel	1302-SA
...-AL	Aluminum - Supra Light Soft Material, Totally Antimagnetic	1302-AL
...-BR	Brass - Soft Material, Totally Antimagnetic	1302-BR
OPTIONS upon Request		Example
Prefix R...	Reverse Action Tweezers. Available only on 1300-SA / 1400-SA, T5500 / T5600 series CW1300-SA / CB1300-SA, CW1300C-SA / CB1300C-SA series	R1302-SA
Suffix ...C	Short Handle (85 mm – 3 1/4") Total Length Including Tips (110 mm – 4 1/3") Available for all Tips: ESD, STD, White DELRIN 500 and Ceramic	1304C-SA
Suffix ...D	Inside Serrated Tip. Available on all series	1302D-SA
Suffix ...-EZ	Patented EZ Lever. Available only on 1300-SA / -AL / -BR / -BSA / -BAL / -BBR series 1400-SA / -AL / -BR / -BSA / -BAL / -BBR series 1800-SA / -AL / -BR / -BSA / -BAL / -BBR series 1900-SA / -AL / -BR / -BSA / -BAL / -BBR series CW / CB1300-SA / -AL / -BR / -BSA / -BAL / -BBR series CW / CB1800-SA / -AL / -BR / -BSA / -BAL / -BBR series 1390W-SA / 1490W-SA, T5500 / T5600 series (page 28) and MD-5500 / MD-5600 (page 29) always come with Patented EZ Lever - No Suffix needed	1302-SA-EZ
Suffix ...-AP	Adjustable Screw Pressure. Available only on Reverse Action Tweezers	R1304-SA-AP



Adjustable Screw Pressure

SC-0 Set of 2 Replacement Screws



SIPEL-0 Screwdriver for
above Screws



EZ-1-ESD Patented EZ lever for T5500 / T5600 series



EZ-2-ESD Patented EZ Lever for 1300 / 1400,
1600 / 1700, 1800 / 1900 series

TECHNICAL INFORMATION

CERAMIC QUICK CHANGE TWEEZERS -See on pages 51-76

Hundreds of Models Available

CW... White Antistatic Ceramic

CB... Black ESD Safe Ceramic



Made in
Switzerland
Patented

This series of Sipel Hi-Tech Tweezers have solid CERAMIC tips that make them ideal for use in the semiconductor Industry. They are resistant to chemicals, highly resistant to static charging, offer unequalled wear and heat resistance. Sipel CERAMIC tweezers are ideal for high precision work when high chemical resistance or complete freedom from any magnetism is required. Ideal for clean room work as nothing will leach out and contaminate the work area. Sipel Quick Change Tips beside coming in more styles and shapes than any other tweezer manufacture come in both White Antistatic Ceramic, code **CW**, and Black ESD Safe Ceramic, code **CB**.

- Antistatic and Static Dissipative
- Precision "Soft Touch" Tips
- Silicone / Chloride Free

- Multi-Handle Configuration Available
- High Wear Temperature Resistance up to 1500°C / 2732°F
- Chemical and Solder Resistant



- Stainless Antiacid Antimagnetic Handle: add suffix **-SA**
- Stainless Antiacid Antimagnetic Short Handle: add suffix **C-SA**
- Aluminum Handle: add suffix **-AL**
- Brass Handle: add suffix **-BR**
- Bent Handle – Stainless Antiacid Antimagnetic: add suffix **-BSA**
- Bent Handle – Aluminum: add suffix **-BAL**
- Bent Handle – Brass: add suffix **-BBR**

Available on the Following series:

- CW / CB1300 Series: **-SA-AL-BR**
- CW / CB1300C Series: **-SA**
- CW / CB1300-B Series: **-BSA-BAL-BBR**
- CW / CB1600 Series: **-SA-AL-BR**
- CW / CB1600-B Series: **-BSA-BAL-BBR**
- CW / CB1800 Series: **-SA-AL-BR**
- CW / CB1800-B Series: **-BSA-BAL-BBR**
- RCW / RCB1300 Series: **-SA**
- RCW / RCB1300C Series: **-SA**

TECHNICAL INFORMATION

QUICK CHANGE Replaceable Tip's MATERIALS GENERAL CHARACTERISTICS



Made in
Switzerland
Patented

BLACK Tips

Industrial Molded Fiber
ESD SAFE
Antimagnetic
No contamination
Heat Resistance : 240°C / 464°F

For 1300 series (pages 6-13, 30-32)
For 1300C series (pages 26-27)
For R1300 series (pages 6-9)
For 1600 series (pages 14-19, 33-35)
For 1800 series (pages 20-25, 36-38)
For 300 series, with Riveted Tip (pages 39-42)
For T5500 series (page 28)
For MD5500 series (page 29)



WHITE Tips

Industrial Molded DELRIN 500
Antistatic
Antimagnetic
No contamination
Waterproof
Heat resistance : 240°C / 464°F

For 1400 series (pages 6-13, 30-32)
For 1400C series (pages 26-27)
For R1400 series (pages 6-9)
For 1700 series (pages 14-19, 33-35)
For 1900 series (pages 20-25, 36-38)
For 400 series, with Riveted Tip (pages 39-42)
For T5600 series (page 28)
For MD5600 series (page 29)



GREY Tips

Industrial Molded Fiber
STD / Static Dissipative
Antimagnetic
No contamination
Heat Resistance : 240°C / 464°F

For 1300 series (pages 6-13, 30-32)
For 1300C series (pages 26-27)
For R1300 series (pages 6-9)
For 1600 series (pages 14-19, 33-35)
For 1800 series (pages 20-25, 36-38)
For 300 series, with Riveted Tip (pages 39-42)
For T5500 series (page 28)
For MD5500 series (page 29)



RED Tips

Industrial Soft Fiber
Antistatic
Antimagnetic
No contamination

For 300-SA, 300F-SA, 300AF-SA, with Riveted Tip (page 43)



CERAMIC Tips

White Antistatic: CW
Black ESD Safe: CB

Zircon
Inert to practically all chemical agents
Even Under High Temperature
Antistatic
No Contamination
Waterproof
Heat Resistance : 1500°C / 2700°F

For CW / CB1300 series (pages 52-53, 58-59, 64-65, 70-71)
For CW / CB1300C series (pages 52-53, 64-65)
For RCW / RCB1300 series (pages 52-53, 64-65)
For CW / CB1600 series (pages 54-55, 60-61, 66-67, 72-73)
For CW / CB1800 series (pages 56-57, 62-63, 68-69, 74-75)



Look for Best Sellers Replaceable Tips on pages 44-50. Other Models Available Upon Request
CUSTOMIZED TIPS ARE AVAILABLE UPON REQUEST
ASK FOR SPECIFIC DATA SHEET FOR ADDITIONAL TECHNICAL INFORMATION ON MATERIALS

TECHNICAL INFORMATION



Made in
Switzerland
Patented

QUICK CHANGE Tweezers' HANDLES - See on pages 77-79

Stainless Antiacid Antimagnetic, suffix "-SA"

Aluminum, suffix "-AL"

Brass, suffix "-BR"

1300C-SA

For 1300C/1300C-STD/1400C series, see pages 26-27
For CW1300C/CB1300C series, see pages 52-53, 64-65

- Available with Patented EZ Lever, add suffix "-EZ"

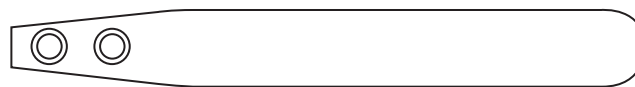

85 mm - 3 1/4"

1300-SA / 1300-AL / 1300-BR

For 1300/1300-STD/1400 series, see pages 6-13
For CW1300/CB1300 series, see pages 52-53, 64-65

- Available with Patented EZ Lever, add suffix "-EZ"



95 mm - 3 3/4"

1300-BSA / 1300-BAL / 1300-BBR

For 1300/1300-STD/1400 series, see pages 30-32
For CW1300-B/CB1300-B series, see pages 58-59, 70-71

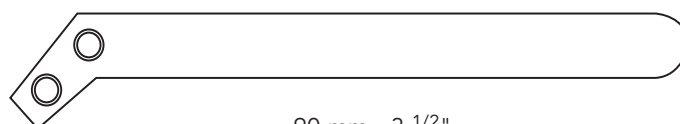

90 mm - 3 1/2"

1300-SA-EZ, with Patented EZ Lever

For 1390W-SA/1390W-SA-STD/1490W-SA
see page 28

- Available in Reverse Action, add Prefix "R"



95 mm - 3 3/4"

1600-SA / 1600-AL / 1600-BR, Serrated Handle

For 1600/ 600-STD/1700 series, see pages 14-19
For CW1600/CB1600 series, see pages 54-55, 66-67



95 mm - 3 3/4"

1600-BSA / 1600-BAL / 1600-BBR, Serrated Handle

For 1600/1600-STD/1700 series, see pages 33-35
For CW1600-B/CB1600-B series, see pages 60-61, 72-73

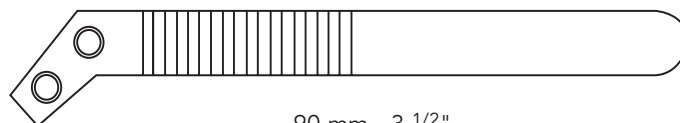

90 mm - 3 1/2"

1800-SA / 1800-AL / 1800-BR

For 1800/1800-STD/1900 series, see pages 20-25
For CW1800/CB1800 series, see pages 56-57, 68-69

- Available with Patented EZ Lever, add suffix "-EZ"

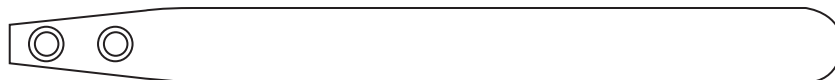

110 mm - 4 1/3"

1800-BSA / 1800-BAL / 1800-BBR

For 1800/1800-STD/1900 series, see pages 36-38
For CW1800-B/CB1800-B series, see pages 62-63, 74-75

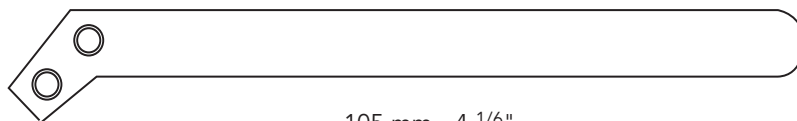

105 mm - 4 1/6"

EACH HANDLE ABOVE COMES WITH 4 CORRESPONDING SCREWS (2 PAIRS)

TECHNICAL INFORMATION



Made in
Switzerland
Patented

QUICK CHANGE Tweezers' HANDLES - See on pages 77-79

Stainless Antiacid Antimagnetic, suffix "-SA"

Aluminum, suffix "-AL"

Brass, suffix "-BR"

T5000-SA, with Patented EZ Lever
For T5508-SA/T5508-SA-STD/T5608-SA,
T5531-SA/T5531-SA-STD/T5631-SA,
T5508W-SA/T5508W-SA-STD/T5608W-SA,
see page 28

- Available in Reverse Action, add Prefix "R"



120 mm - 4 3/4"

TS5000-SA, with Patented EZ Lever, Serrated
Handle

For T5509W-SA/T5509W-SA-STD/T5609W-
SA,T5510W-SA/T5510W-SA-STD/T5610W-SA,
see page 28

- Available in Reverse Action, add Prefix "R"

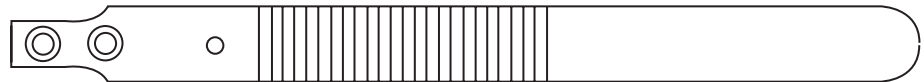

120 mm - 4 3/4"

R1300-SA

For R1300/R1300-STD/R1400 series, see page
6-9. For RCW1300/RCB1300 series, see page
52-53, 64-65

- Available with Adjustable Screw Pressure,
add suffix "-AP"



95 mm - 3 3/4"

R1300C-SA

For R1300C/R1300C-STD/R1400C
For RCW1300C/RCB1300C

- Available with Adjustable Screw Pressure,
add suffix "-AP"



85 mm - 3 1/4"

EACH HANDLE ABOVE COMES WITH 4 CORRESPONDING SCREWS (2 PAIRS)
FOR ADJUSTABLE SCREW PRESSURE ON REVERSE ACTION HANDLE, ADD SUFFIX "-AP" (example RT5000-SA-AP)









QUICK CHANGE TWEEZERS - 1300-SA / 1300-SA-STD / 1400-SA series
Stainless Antiacid Antimagnetic Handle

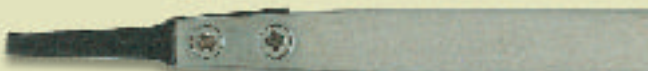

Made in Switzerland
Patented

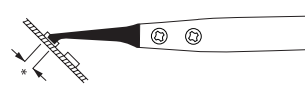

- 1300-SA series with Black ESD Safe Tip
1300-SA-STD series with Grey Static Dissipative Tip
1400-SA series with White DELRIN 500 Tip
- Available in Reverse Action, add prefix "R" (example R1302-SA)
 - Available with Patented EZ Lever, add suffix "-EZ" (example 1302-SA-EZ)
 - Available with Inside Serrated Tip, add suffix "D" (example 1302D-SA)

<p>1302-SA Black ESD Safe 1302-SA-STD Grey Static Dissipative 1402-SA White DELRIN 500 • Medium Tip</p>	<p>120 mm - 4 3/4" 120 mm - 4 3/4" 120 mm - 4 3/4"</p>	 <p>* 2 mm - .08"</p>	
<p>1303-SA Black ESD Safe 1303-SA-STD Grey Static Dissipative 1403-SA White DELRIN 500 • Strong Flat Tip</p>	<p>115 mm - 4 1/2" 115 mm - 4 1/2" 115 mm - 4 1/2"</p>	 <p>* 2.3 mm - .09"</p>	
<p>1304-SA Black ESD Safe 1304-SA-STD Grey Static Dissipative 1404-SA White DELRIN 500 • Fine Tip</p>	<p>120 mm - 4 3/4" 120 mm - 4 3/4" 120 mm - 4 3/4"</p>	 <p>* 0.6 mm - .023"</p>	
<p>1304B-SA Black ESD Safe 1304B-SA-STD Grey Static Dissipative 1404B-SA White DELRIN 500 • Curved Fine Tip</p>	<p>120 mm - 4 3/4" 120 mm - 4 3/4" 120 mm - 4 3/4"</p>	 <p>* 0.6 mm - .023"</p>	
<p>1306-SA Black ESD Safe 1306-SA-STD Grey Static Dissipative 1406-SA White DELRIN 500 • Strong Angulated SMD Flat Tip</p>	<p>120 mm - 4 3/4" 120 mm - 4 3/4" 120 mm - 4 3/4"</p>	 <p>* 2.5 mm - .1"</p>	

















QUICK CHANGE TWEEZERS - 1300-SA / 1300-SA-STD / 1400-SA series



Made in Switzerland
Patented

Stainless Antiacid Antimagnetic Handle

- Available in Reverse Action, add prefix "R" (example R1309-SA)
- Available with Patented EZ Lever, add suffix "-EZ" (example 1309-SA-EZ)
- Available with Inside Serrated Tip, add suffix "D" (example 1309D-SA)

<p>1309-SA Black ESD Safe 1309-SA-STD Grey Static Dissipative 1409-SA White DELRIN 500 • Fine Angulated SMD Flat Tip</p>	<p>115 mm - 4 1/2" 115 mm - 4 1/2" 115 mm - 4 1/2"</p>	 * 1.5 mm - .06"	
<p>1310A-SA Black ESD Safe 1310A-SA-STD Grey Static Dissipative 1410A-SA White DELRIN 500 • Very Small Fine Angulated SMD Flat Tip</p>	<p>115 mm - 4 1/2" 115 mm - 4 1/2" 115 mm - 4 1/2"</p>	 * 0.6 mm - .023"	
<p>1315-SA Black ESD Safe 1315-SA-STD Grey Static Dissipative 1415-SA White DELRIN 500 • Extra Fine Tip</p>	<p>120 mm - 4 3/4" 120 mm - 4 3/4" 120 mm - 4 3/4"</p>	 * 0.3 mm - .011"	
<p>1316-SA Black ESD Safe 1316-SA-STD Grey Static Dissipative 1416-SA White DELRIN 500 • Very Fine Tip</p>	<p>120 mm - 4 3/4" 120 mm - 4 3/4" 120 mm - 4 3/4"</p>	 * 0.5 mm - .019"	
<p>1317-SA Black ESD Safe 1317-SA-STD Grey Static Dissipative 1417-SA White DELRIN 500 • Flat Tip</p>	<p>120 mm - 4 3/4" 120 mm - 4 3/4" 120 mm - 4 3/4"</p>	 * 1.5 mm - .06"	
<p>1317B-SA Black ESD Safe 1317B-SA-STD Grey Static Dissipative 1417B-SA White DELRIN 500 • Curved Flat Tip</p>	<p>120 mm - 4 3/4" 120 mm - 4 3/4" 120 mm - 4 3/4"</p>	 * 1.5 mm - .06"	
<p>1318-SA Black ESD Safe 1318-SA-STD Grey Static Dissipative 1418-SA White DELRIN 500 • For Handling and Positioning Quad Packs and Flat Parts</p>	<p>120 mm - 4 3/4" 120 mm - 4 3/4" 120 mm - 4 3/4"</p>	 groove Ø 1 mm - .04"	
<p>1324-SA Black ESD Safe 1324-SA-STD Grey Static Dissipative 1424-SA White DELRIN 500 • Very Fine Angulated Flat Tip</p>	<p>120 mm - 4 3/4" 120 mm - 4 3/4" 120 mm - 4 3/4"</p>	 * 0.5 mm - .019"	

QUICK CHANGE TWEEZERS - 1300-SA / 1300-SA-STD / 1400-SA series



Made in Switzerland
Patented

Stainless Antiacid Antimagnetic Handle

- Available in Reverse Action, add prefix "R" (example R1350-SA)
- Available with Patented EZ Lever, add suffix "-EZ" (example 1350-SA-EZ)
- Available with inside serrated Tip, add suffix "D" (example 1350D-SA)

<p>1318H-SA 120 mm - 4 3/4" Black ESD Safe 1318H-SA-STD 120 mm - 4 3/4" Grey Static Dissipative 1418H-SA 120 mm - 4 3/4" White DELRIN 500 • Perpendicular Groove Radius \varnothing 1.7 mm -.066" for Handlig Lenses and Flat Round Parts</p>		
<p>1318V-SA 120 mm - 4 3/4" Black ESD Safe 1318V-SA-STD 120 mm - 4 3/4" Grey Static Dissipative 1418V-SA 120 mm - 4 3/4" White DELRIN 500 • For Handling Screws and Small Round Parts</p>		
<p>1319H-SA 120 mm - 4 3/4" Black ESD Safe 1319H-SA-STD 120 mm - 4 3/4" Grey Static Dissipative 1419H-SA 120 mm - 4 3/4" White DELRIN 500 • Horizontal Groove, for Handling Lenses and Flat Round Parts</p>		
<p>1320-SA / 1320A-SA (45°) 120 mm - 4 3/4" Black ESD Safe 1320-SA-STD/1320A-SA-STD(45°) 120 mm - 4 3/4" Grey Static Dissipative 1420-SA / 1420A-SA (45°) 120 mm - 4 3/4" White DELRIN 500 • For Handling Components, \varnothing 1.5 mm -.06" Hole</p>		
<p>1322-SA / 1322A-SA (45°) 120 mm - 4 3/4" Black ESD Safe 1322-SA-STD/1322A-SA-STD(45°) 120 mm - 4 3/4" Grey Static Dissipative 1422-SA / 1422A-SA (45°) 120 mm - 4 3/4" White DELRIN 500 • For Handling Components, \varnothing 2.5 mm -.1" Hole</p>		
<p>1323C-SA 110 mm - 4 1/3" Black ESD Safe 1323C-SA-STD 110 mm - 4 1/3" Grey Static Dissipative 1423C-SA 110 mm - 4 1/3" White DELRIN 500 • With Unique Hole Positioning, Grasping a Ball Bearing of Almost any Size, From any Angle</p>		
<p>R1330A-SA 150 mm - 6" Black ESD Safe R1330A-SA-STD 150 mm - 6" Grey Static Dissipative R1430A-SA 150 mm - 6" White DELRIN 500 • Reverse Action Only. For Handling and Positioning Large Quad Packs and Flat Parts</p>	<p>groove \varnothing 1 mm -.04" opening from 15 mm -.6" up to 45 mm - 1 3/4"</p>	
<p>1350-SA 115 mm - 4 1/2" Black ESD Safe 1350-SA-STD 115 mm - 4 1/2" Grey Static Dissipative 1450-SA 115 mm - 4 1/2" White DELRIN 500 • Wafer and Round Part Handling Tweezer</p>	<p>* 10 mm -.4"</p>	

QUICK CHANGE TWEEZERS - 1300-SA / 1300-SA-STD / 1400-SA series



Made in Switzerland
Patented

Stainless Antiacid Antimagnetic Handle

- Available in Reverse Action, add prefix "R" (example R1352-SA)
- Available with Patented EZ Lever, add suffix "-EZ" (example 1352SA-EZ)
- Available with inside serrated Tip, add suffix "D" (example 1352D-SA)

<p>1351-SA Black ESD Safe 1351-SA-STD Grey Static Dissipative 1451-SA White DELRIN 500 • For Handling Components, Ø 1mm -.04" Hole</p>	<p>115 mm - 4 1/2" 115 mm - 4 1/2" 115 mm - 4 1/2"</p>	<p>* Ø 1 mm - .04"</p>	
<p>1352-SA Black ESD Safe 1352-SA-STD Grey Static Dissipative 1452-SA White DELRIN 500 • Strong Angulated Flat Tip</p>	<p>115 mm - 4 1/2" 115 mm - 4 1/2" 115 mm - 4 1/2"</p>	<p>* 2.5 mm - .1"</p>	
<p>1353-SA Black ESD Safe 1353-SA-STD Grey Static Dissipative 1453-SA White DELRIN 500 • Angulated Fine Tip</p>	<p>115 mm - 4 1/2" 115 mm - 4 1/2" 115 mm - 4 1/2"</p>	<p>* 1 mm - .04"</p>	
<p>1354-SA Black ESD Safe 1354-SA-STD Grey Static Dissipative 1454-SA White DELRIN 500 • Curved Fine Tip</p>	<p>115 mm - 4 1/2" 115 mm - 4 1/2" 115 mm - 4 1/2"</p>	<p>* 1 mm - .04"</p>	
<p>1355-SA Black ESD Safe 1355-SA-STD Grey Static Dissipative 1455-SA White DELRIN 500 • Strong Curved Tip</p>	<p>115 mm - 4 1/2" 115 mm - 4 1/2" 115 mm - 4 1/2"</p>	<p>* 2 mm - .08"</p>	
<p>1356-SA Black ESD Safe 1356-SA-STD Grey Static Dissipative 1456-SA White DELRIN 500 • Straight Strong Flat Tip</p>	<p>115 mm - 4 1/2" 115 mm - 4 1/2" 115 mm - 4 1/2"</p>	<p>* 2 mm - .08"</p>	
<p>1357-SA Black ESD Safe 1357-SA-STD Grey Static Dissipative 1457-SA White DELRIN 500 • Fine Straight Flat Tip</p>	<p>115 mm - 4 1/2" 115 mm - 4 1/2" 115 mm - 4 1/2"</p>	<p>* 1 mm - .04"</p>	

QUICK CHANGE TWEEZERS - 1300-AL / 1300-AL-STD / 1400-AL series

Aluminum Handle



Made in Switzerland
Patented



1300-AL series with Black ESD Safe Tip
 1300-AL-STD series with Grey Static Dissipative Tip
 1400-AL series with White DELRIN 500 Tip

- Available with Patented EZ Lever, add suffix "-EZ" (example 1302-AL-EZ)
- Available with Inside Serrated Tip, add suffix "D" (example 1302D-AL)

<p>1302-AL Black ESD Safe</p> <p>1302-AL-STD Grey Static Dissipative</p> <p>1402-AL White DELRIN 500</p> <ul style="list-style-type: none"> • MediumTip 	<p>120 mm - 4 3/4"</p> <p>120 mm - 4 3/4"</p> <p>120 mm - 4 3/4"</p>	<p>* 2 mm - .08"</p>	
<p>1303-AL Black ESD Safe</p> <p>1303-AL-STD Grey Static Dissipative</p> <p>1403-AL White DELRIN 500</p> <ul style="list-style-type: none"> • Strong Flat Tip 	<p>115 mm - 4 1/2"</p> <p>115 mm - 4 1/2"</p> <p>115 mm - 4 1/2"</p>	<p>* 2.3 mm - .09"</p>	
<p>1304-AL Black ESD Safe</p> <p>1304-AL-STD Grey Static Dissipative</p> <p>1404-AL White DELRIN 500</p> <ul style="list-style-type: none"> • Fine Tip 	<p>120 mm - 4 3/4"</p> <p>120 mm - 4 3/4"</p> <p>120 mm - 4 3/4"</p>	<p>* 0.6 mm - .023"</p>	
<p>1304B-AL Black ESD Safe</p> <p>1304B-AL-STD Grey Static Dissipative</p> <p>1404B-AL White DELRIN 500</p> <ul style="list-style-type: none"> • Curved Fine Tip 	<p>120 mm - 4 3/4"</p> <p>120 mm - 4 3/4"</p> <p>120 mm - 4 3/4"</p>	<p>* 0.6 mm - .023"</p>	
<p>1306-AL Black ESD Safe</p> <p>1306-AL-STD Grey Static Dissipative</p> <p>1406-AL White DELRIN 500</p> <ul style="list-style-type: none"> • Strong Angulated SMD Flat Tip 	<p>120 mm - 4 3/4"</p> <p>120 mm - 4 3/4"</p> <p>120 mm - 4 3/4"</p>	<p>* 2.5 mm - .1"</p>	

















QUICK CHANGE TWEEZERS - 1300-AL / 1300-AL-STD / 1400-AL series

Aluminum Handle

- Available with Patented EZ Lever, add suffix "-EZ" (example 1309-AL-EZ)
- Available with Inside Serrated Tip, add suffix "D" (example 1309D-AL)



Made in Switzerland
Patented

<p>1309-AL Black ESD Safe 1309-AL-STD Grey Static Dissipative 1409-AL White DELRIN 500 • Fine Angulated SMD Flat Tip</p>	<p>115 mm - 4 1/2"</p> <p>115 mm - 4 1/2"</p> <p>115 mm - 4 1/2"</p>	 <p>* 1.5 mm - .06"</p>	
<p>1310A-AL Black ESD Safe 1310A-AL-STD Grey Static Dissipative 1410A-AL White DELRIN 500 • Very Small Fine Angulated SMD Flat Tip</p>	<p>115 mm - 4 1/2"</p> <p>115 mm - 4 1/2"</p> <p>115 mm - 4 1/2"</p>	 <p>* 0.6 mm - .023"</p>	
<p>1315-AL Black ESD Safe 1315-AL-STD Grey Static Dissipative 1415-AL White DELRIN 500 • Extra Fine Tip</p>	<p>120 mm - 4 3/4"</p> <p>120 mm - 4 3/4"</p> <p>120 mm - 4 3/4"</p>	 <p>* 0.3 mm - .011"</p>	
<p>1316-AL Black ESD Safe 1316-AL-STD Grey Static Dissipative 1416-AL White DELRIN 500 • Very Fine Tip</p>	<p>120 mm - 4 3/4"</p> <p>120 mm - 4 3/4"</p> <p>120 mm - 4 3/4"</p>	 <p>* 0.5 mm - .019"</p>	
<p>1317-AL Black ESD Safe 1317-AL-STD Grey Static Dissipative 1417-AL White DELRIN 500 • Flat Tip</p>	<p>120 mm - 4 3/4"</p> <p>120 mm - 4 3/4"</p> <p>120 mm - 4 3/4"</p>	 <p>* 1.5 mm - .06"</p>	
<p>1317B-AL Black ESD Safe 1317B-AL-STD Grey Static Dissipative 1417B-AL White DELRIN 500 • Curved Flat Tip</p>	<p>120 mm - 4 3/4"</p> <p>120 mm - 4 3/4"</p> <p>120 mm - 4 3/4"</p>	 <p>* 1.5 mm - .06"</p>	
<p>1318-AL Black ESD Safe 1318-AL-STD Grey Static Dissipative 1418-AL White DELRIN 500 • For Handling and Positioning Quad Packs and Flat Parts</p>	<p>120 mm - 4 3/4"</p> <p>120 mm - 4 3/4"</p> <p>120 mm - 4 3/4"</p>	 <p>groove Ø 1 mm - .04"</p>	
<p>1324-AL Black ESD Safe 1324-AL-STD Grey Static Dissipative 1424-AL White DELRIN 500 • Very Fine Angulated Flat Tip</p>	<p>120 mm - 4 3/4"</p> <p>120 mm - 4 3/4"</p> <p>120 mm - 4 3/4"</p>	 <p>* 0.5 mm - .019"</p>	

QUICK CHANGE TWEEZERS - 1300-BR / 1300-BR-STD / 1400-BR series

Brass Handle



Made in Switzerland
Patented

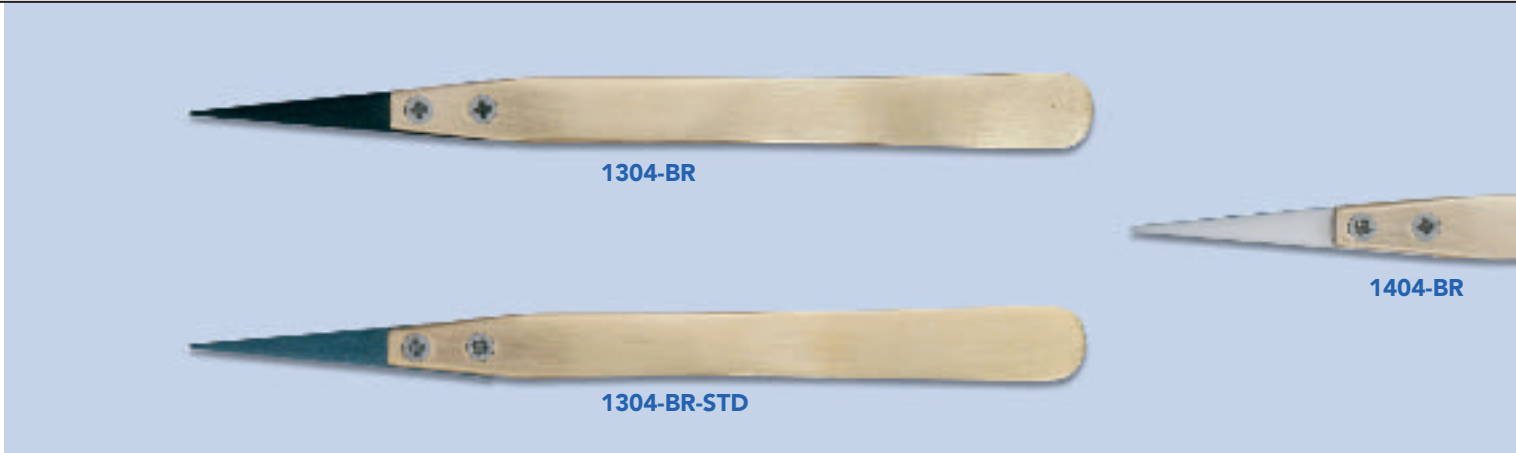

1300-BR series with Black ESD Safe Tip
1300-BR-STD series with Grey Static Dissipative Tip
1400-BR series with White DELRIN 500 Tip

- Available with Patented EZ Lever, add suffix "-EZ" (example 1302-BR-EZ)
- Available with Inside Serrated Tip, add suffix "D" (example 1302D-BR)

<p>1302-BR Black ESD Safe</p> <p>1302-BR-STD Grey Static Dissipative</p> <p>1402-BR White DELRIN 500</p> <ul style="list-style-type: none"> • Medium Tip 	<p>120 mm - 4 3/4"</p> <p>120 mm - 4 3/4"</p> <p>120 mm - 4 3/4"</p>	<p>* 2 mm - .08"</p>	
<p>1303-BR Black ESD Safe</p> <p>1303-BR-STD Grey Static Dissipative</p> <p>1403-BR White DELRIN 500</p> <ul style="list-style-type: none"> • Strong Flat Tip 	<p>115 mm - 4 1/2"</p> <p>115 mm - 4 1/2"</p> <p>115 mm - 4 1/2"</p>	<p>* 2.3 mm - .09"</p>	
<p>1304-BR Black ESD Safe</p> <p>1304-BR-STD Grey Static Dissipative</p> <p>1404-BR White DELRIN 500</p> <ul style="list-style-type: none"> • Fine Tip 	<p>120 mm - 4 3/4"</p> <p>120 mm - 4 3/4"</p> <p>120 mm - 4 3/4"</p>	<p>* 0.6 mm - .023"</p>	
<p>1304B-BR Black ESD Safe</p> <p>1304B-BR-STD Grey Static Dissipative</p> <p>1404B-BR White DELRIN 500</p> <ul style="list-style-type: none"> • Curved Fine Tip 	<p>120 mm - 4 3/4"</p> <p>120 mm - 4 3/4"</p> <p>120 mm - 4 3/4"</p>	<p>* 0.6 mm - .023"</p>	
<p>1306-BR Black ESD Safe</p> <p>1306-BR-STD Grey Static Dissipative</p> <p>1406-BR White DELRIN 500</p> <ul style="list-style-type: none"> • Strong Angulated SMD Flat Tip 	<p>120 mm - 4 3/4"</p> <p>120 mm - 4 3/4"</p> <p>120 mm - 4 3/4"</p>	<p>* 2.5 mm - .1"</p>	

QUICK CHANGE TWEEZERS - 1300-BR / 1300-BR-STD / 1400-BR series



Made in Switzerland
Patented

Brass Handle

- Available with Patented EZ Lever, add suffix "-EZ" (example 1309-BR-EZ)
- Available with Inside Serrated Tip, add suffix "D" (example 1309D-BR)

<p>1309-BR Black ESD Safe 1309-BR-STD Grey Static Dissipative 1409-BR White DELRIN 500 • Fine Angulated SMD Flat Tip</p>	<p>115 mm - 4 1/2" 115 mm - 4 1/2" 115 mm - 4 1/2"</p>	 * 1.5 mm - .06"	
<p>1310A-BR Black ESD Safe 1310A-BR-STD Grey Static Dissipative 1410A-BR White DELRIN 500 • Very Small Fine Angulated SMD Flat Tip</p>	<p>115 mm - 4 1/2" 115 mm - 4 1/2" 115 mm - 4 1/2"</p>	 * 0.6 mm - .023"	
<p>1315-BR Black ESD Safe 1315-BR-STD Grey Static Dissipative 1415-BR White DELRIN 500 • Extra Fine Tip</p>	<p>120 mm - 4 3/4" 120 mm - 4 3/4" 120 mm - 4 3/4"</p>	 * 0.3 mm - .011"	
<p>1316-BR Black ESD Safe 1316-BR-STD Grey Static Dissipative 1416-BR White DELRIN 500 • Very Fine Tip</p>	<p>120 mm - 4 3/4" 120 mm - 4 3/4" 120 mm - 4 3/4"</p>	 * 0.5 mm - .019"	
<p>1317-BR Black ESD Safe 1317-BR-STD Grey Static Dissipative 1417-BR White DELRIN 500 • Flat Tip</p>	<p>120 mm - 4 3/4" 120 mm - 4 3/4" 120 mm - 4 3/4"</p>	 * 1.5 mm - .06"	
<p>1317B-BR Black ESD Safe 1317B-BR-STD Grey Static Dissipative 1417B-BR White DELRIN 500 • Curved Flat Tip</p>	<p>120 mm - 4 3/4" 120 mm - 4 3/4" 120 mm - 4 3/4"</p>	 * 1.5 mm - .06"	
<p>1318-BR Black ESD Safe 1318-BR-STD Grey Static Dissipative 1418-BR White DELRIN 500 • For Handling and Positioning Quad Packs and Flat Parts</p>	<p>120 mm - 4 3/4" 120 mm - 4 3/4" 120 mm - 4 3/4"</p>	 groove Ø 1 mm - .04"	
<p>1324-BR Black ESD Safe 1324-BR-STD Grey Static Dissipative 1424-BR White DELRIN 500 • Very Fine Angulated Flat Tip</p>	<p>120 mm - 4 3/4" 120 mm - 4 3/4" 120 mm - 4 3/4"</p>	 * 0.5 mm - .019"	

QUICK CHANGE TWEEZERS - 1600-SA / 1600-SA-STD / 1700-SA series

Stainless Antiacid Antimagnetic Serrated Handle



Made in Switzerland
Patented



1600-SA series with Black ESD Safe Tip
1600-SA-STD series with Grey Static Dissipative Tip
1700-SA series with White DELRIN 500 Tip

- Available with Inside Serrated Tip, add suffix "D" (example 1602D-SA)

<p>1602-SA Black ESD Safe</p> <p>1602-SA-STD Grey Static Dissipative</p> <p>1702-SA White DELRIN 500</p> <ul style="list-style-type: none"> • Medium Tip 	<p>120 mm - 4 3/4"</p> <p>120 mm - 4 3/4"</p> <p>120 mm - 4 3/4"</p>	<p>* 2 mm - .08"</p>	
<p>1603-SA Black ESD Saf</p> <p>1603-SA-STD Grey Static Dissipative</p> <p>1703-SA White DELRIN 500</p> <ul style="list-style-type: none"> • Strong Flat Tip 	<p>115 mm - 4 1/2"</p> <p>115 mm - 4 1/2"</p> <p>115 mm - 4 1/2"</p>	<p>* 2.3 mm - .09"</p>	
<p>1604-SA Black ESD Safe</p> <p>1604-SA-STD Grey Static Dissipative</p> <p>1704-SA White DELRIN 500</p> <ul style="list-style-type: none"> • Fine Tip 	<p>120 mm - 4 3/4"</p> <p>120 mm - 4 3/4"</p> <p>120 mm - 4 3/4"</p>	<p>* 0.6 mm - .023"</p>	
<p>1604B-SA Black ESD Safe</p> <p>1604B-SA-STD Grey Static Dissipative</p> <p>1704B-SA White DELRIN 500</p> <ul style="list-style-type: none"> • Curved Fine Tip 	<p>120 mm - 4 3/4"</p> <p>120 mm - 4 3/4"</p> <p>120 mm - 4 3/4"</p>	<p>* 0.6 mm - .023"</p>	
<p>1606-SA Black ESD Safe</p> <p>1606-SA-STD Grey Static Dissipativ</p> <p>1706-SA White DELRIN 500</p> <ul style="list-style-type: none"> • Strong Angulated SMD Flat Tip 	<p>120 mm - 4 3/4"</p> <p>120 mm - 4 3/4"</p> <p>120 mm - 4 3/4"</p>	<p>* 2.5 mm - .1"</p>	

QUICK CHANGE TWEEZERS - 1600-SA / 1600-SA-STD / 1700-SA series

Stainless Antiacid Antimagnetic Serrated Handle

- Available with Inside Serrated Tip, add suffix "D" (example 1609D-SA)



Made in Switzerland
Patented

<p>1609-SA Black ESD Safe</p> <p>1609-SA-STD Grey Static Dissipative</p> <p>1709-SA White DELRIN 500</p> <ul style="list-style-type: none"> • Fine Angulated SMD Flat Tip 	<p>115 mm - 4 1/2"</p> <p>115 mm - 4 1/2"</p> <p>115 mm - 4 1/2"</p>	<p>* 1.5 mm - .06"</p>	
<p>1610A-SA Black ESD Safe</p> <p>1610A-SA-STD Grey Static Dissipative</p> <p>1710A-SA White DELRIN 500</p> <ul style="list-style-type: none"> • Very Small Fine Angulated SMD Flat Tip 	<p>115 mm - 4 1/2"</p> <p>115 mm - 4 1/2"</p> <p>115 mm - 4 1/2"</p>	<p>* 0.6 mm - .023"</p>	
<p>1615-SA Black ESD Safe</p> <p>1615-SA-STD Grey Static Dissipative</p> <p>1715-SA White DELRIN 500</p> <ul style="list-style-type: none"> • Extra Fine Tip 	<p>120 mm - 4 3/4"</p> <p>120 mm - 4 3/4"</p> <p>120 mm - 4 3/4"</p>	<p>* 0.3 mm - .011"</p>	
<p>1616-SA Black ESD Safe</p> <p>1616-SA-STD Grey Static Dissipative</p> <p>1716-SA White DELRIN 500</p> <ul style="list-style-type: none"> • Very Fine Tip 	<p>120 mm - 4 3/4"</p> <p>120 mm - 4 3/4"</p> <p>120 mm - 4 3/4"</p>	<p>* 0.5 mm - .019"</p>	
<p>1617-SA Black ESD Safe</p> <p>1617-SA-STD Grey Static Dissipative</p> <p>1717-SA White DELRIN 500</p> <ul style="list-style-type: none"> • Flat Tip 	<p>120 mm - 4 3/4"</p> <p>120 mm - 4 3/4"</p> <p>120 mm - 4 3/4"</p>	<p>* 1.5 mm - .06"</p>	
<p>1617B-SA Black ESD Safe</p> <p>1617B-SA-STD Grey Static Dissipative</p> <p>1717B-SA White DELRIN 500</p> <ul style="list-style-type: none"> • Curved Flat Tip 	<p>120 mm - 4 3/4"</p> <p>120 mm - 4 3/4"</p> <p>120 mm - 4 3/4"</p>	<p>* 1.5 mm - .06"</p>	
<p>1618-SA Black ESD Safe</p> <p>1618-SA-STD Grey Static Dissipative</p> <p>1718-SA White DELRIN 500</p> <ul style="list-style-type: none"> • For Handling and Positioning Quad Packs and Flat Parts 	<p>120 mm - 4 3/4"</p> <p>120 mm - 4 3/4"</p> <p>120 mm - 4 3/4"</p>	<p>groove Ø1 mm - .04"</p>	
<p>1624-SA Black ESD Safe</p> <p>1624-SA-STD Grey Static Dissipative</p> <p>1724-SA White DELRIN 500</p> <ul style="list-style-type: none"> • Very Fine Angulated Flat Tip 	<p>120 mm - 4 3/4"</p> <p>120 mm - 4 3/4"</p> <p>120 mm - 4 3/4"</p>	<p>* 0.5 mm - .019"</p>	

QUICK CHANGE TWEEZERS - 1600-AL / 1600-AL-STD / 1700-AL series

Aluminum Serrated Handle



Made in Switzerland
Patented

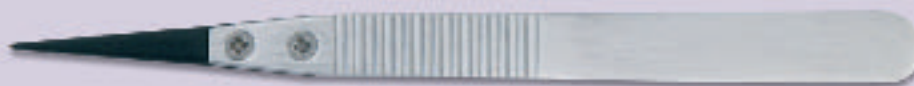

1604-AL



1704-AL

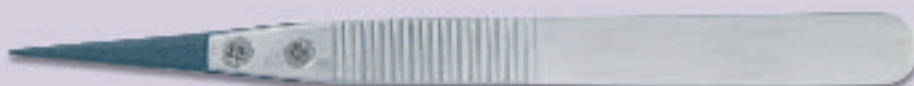

1604-AL-STD

1600-AL series with Black ESD Safe Tip
1600-AL-STD series with Grey Static Dissipative Tip
1700-AL series with White DELRIN 500 Tip

- Available with Inside Serrated Tip, add suffix "D" (example 1602D-AL)

<p>1602-AL Black ESD Safe</p> <p>1602-AL-STD Grey Static Dissipative</p> <p>1702-AL White DELRIN 500</p> <ul style="list-style-type: none"> • Medium Tip 	<p>120 mm - 4 3/4"</p> <p>120 mm - 4 3/4"</p> <p>120 mm - 4 3/4"</p>	<p>* 2 mm - .08"</p>	
<p>1603-AL Black ESD Safe</p> <p>1603-AL-STD Grey Static Dissipative</p> <p>1703-AL White DELRIN 500</p> <ul style="list-style-type: none"> • Strong Flat Tip 	<p>115 mm - 4 1/2"</p> <p>115 mm - 4 1/2"</p> <p>115 mm - 4 1/2"</p>	<p>* 2.3 mm - .09"</p>	
<p>1604-AL Black ESD Safe</p> <p>1604-AL-STD Grey Static Dissipative</p> <p>1704-AL White DELRIN 500</p> <ul style="list-style-type: none"> • Fine Tip 	<p>120 mm - 4 3/4"</p> <p>120 mm - 4 3/4"</p> <p>120 mm - 4 3/4"</p>	<p>* 0.6 mm - .023"</p>	
<p>1604B-AL Black ESD Safe</p> <p>1604B-AL-STD Grey Static Dissipative</p> <p>1704B-AL White DELRIN 500</p> <ul style="list-style-type: none"> • Curved Fine Tip 	<p>120 mm - 4 3/4"</p> <p>120 mm - 4 3/4"</p> <p>120 mm - 4 3/4"</p>	<p>* 0.6 mm - .023"</p>	
<p>1606-AL Black ESD Safe</p> <p>1606-AL-STD Grey Static Dissipative</p> <p>1706-AL White DELRIN 500</p> <ul style="list-style-type: none"> • Strong Angulated SMD Flat Tip 	<p>120 mm - 4 3/4"</p> <p>120 mm - 4 3/4"</p> <p>120 mm - 4 3/4"</p>	<p>* 2.5 mm - .1"</p>	

QUICK CHANGE TWEEZERS - 1600-AL / 1600-AL-STD / 1700-AL series

Aluminum Serrated Handle

- Available with Inside Serrated Tip, add suffix "D" (example 1609D-AL)



Made in Switzerland
Patented

<p>1609-AL Black ESD Safe 1609-AL-STD Grey Static Dissipative 1709-AL White DELRIN 500 • Fine Angulated SMD Flat Tip</p>	<p>115 mm - 4 1/2" 115 mm - 4 1/2" 115 mm - 4 1/2"</p>	 <p>* 1.5 mm - .06"</p>	
<p>1610A-AL Black ESD Safe 1610A-AL-STD Grey Static Dissipative 1710A-AL White DELRIN 500 • Very Small Fine Angulated SMD Flat Tip</p>	<p>115 mm - 4 1/2" 115 mm - 4 1/2" 115 mm - 4 1/2"</p>	 <p>* 0.6 mm - .023"</p>	
<p>1615-AL Black ESD Safe 1615-AL-STD Grey Static Dissipative 1715-AL White DELRIN 500 • Extra Fine Tip</p>	<p>120 mm - 4 3/4" 120 mm - 4 3/4" 120 mm - 4 3/4"</p>	 <p>* 0.3 mm - .011"</p>	
<p>1616-AL Black ESD Safe 1616-AL-STD Grey Static Dissipative 1716-AL White DELRIN 500 • Very Fine Tip</p>	<p>120 mm - 4 3/4" 120 mm - 4 3/4" 120 mm - 4 3/4"</p>	 <p>* 0.5 mm - .019"</p>	
<p>1617-AL Black ESD Safe 1617-AL-STD Grey Static Dissipative 1717-AL White DELRIN 500 • Flat Tip</p>	<p>120 mm - 4 3/4" 120 mm - 4 3/4" 120 mm - 4 3/4"</p>	 <p>* 1.5 mm - .06"</p>	
<p>1617B-AL Black ESD Safe 1617B-AL-STD Grey Static Dissipative 1717B-AL White DELRIN 500 • Curved Flat Tip</p>	<p>120 mm - 4 3/4" 120 mm - 4 3/4" 120 mm - 4 3/4"</p>	 <p>* 1.5 mm - .06"</p>	
<p>1618-AL Black ESD Safe 1618-AL-STD Grey Static Dissipative 1718-AL White DELRIN 500 • For Handling and Positioning Quad Packs and Flat Parts</p>	<p>120 mm - 4 3/4" 120 mm - 4 3/4" 120 mm - 4 3/4"</p>	 <p>groove Ø 1 mm - .04"</p>	
<p>1624-AL Black ESD Safe 1624-AL-STD Grey Static Dissipative 1724-AL White DELRIN 500 • Very Fine Angulated Flat Tip</p>	<p>120 mm - 4 3/4" 120 mm - 4 3/4" 120 mm - 4 3/4"</p>	 <p>* 0.5 mm - .019"</p>	

QUICK CHANGE TWEEZERS - 1600-BR / 1600-BR-STD / 1700-BR series

Brass Serrated Handle



Made in Switzerland
Patented



1600-BR series with Black ESD Safe Tip
1600-BR-STD series with Grey Static Dissipative Tip
1700-BR series with White DELRIN 500 Tip

- Available with Inside Serrated Tip, add suffix "D" (example 1602D-BR)

<p>1602-BR Black ESD Safe</p> <p>1602-BR-STD Grey Static Dissipative</p> <p>1702-BR White DELRIN 500</p> <ul style="list-style-type: none"> • Medium Tip 	<p>120 mm - 4 3/4"</p> <p>120 mm - 4 3/4"</p> <p>120 mm - 4 3/4"</p>	<p>* 2 mm - .08"</p>	
<p>1603-BR Black ESD Safe</p> <p>1603-BR-STD Grey Static Dissipative</p> <p>1703-BR White DELRIN 500</p> <ul style="list-style-type: none"> • Strong Flat Tip 	<p>115 mm - 4 1/2"</p> <p>115 mm - 4 1/2"</p> <p>115 mm - 4 1/2"</p>	<p>* 2.3 mm - .09"</p>	
<p>1604-BR Black ESD Safe</p> <p>1604-BR-STD Grey Static Dissipative</p> <p>1704-BR White DELRIN 500</p> <ul style="list-style-type: none"> • Fine Tip 	<p>120 mm - 4 3/4"</p> <p>120 mm - 4 3/4"</p> <p>120 mm - 4 3/4"</p>	<p>* 0.6 mm - .023"</p>	
<p>1604B-BR Black ESD Safe</p> <p>1604B-BR-STD Grey Static Dissipative</p> <p>1704B-BR White DELRIN 500</p> <ul style="list-style-type: none"> • Curved Fine Tip 	<p>120 mm - 4 3/4"</p> <p>120 mm - 4 3/4"</p> <p>120 mm - 4 3/4"</p>	<p>* 0.6 mm - .023"</p>	
<p>1606-BR Black ESD Safe</p> <p>1606-BR-STD Grey Static Dissipative</p> <p>1706-BR White DELRIN 500</p> <ul style="list-style-type: none"> • Strong Angulated SMD Flat Tip 	<p>120 mm - 4 3/4"</p> <p>120 mm - 4 3/4"</p> <p>120 mm - 4 3/4"</p>	<p>* 2.5 mm - .1"</p>	

QUICK CHANGE TWEEZERS - 1600-BR / 1600-BR-STD / 1700-BR series

Brass Serrated Handle

- Available with Inside Serrated Tip, add suffix "D" (example 1609D-BR)



Made in Switzerland
Patented

<p>1609-BR Black ESD Safe 1609-BR-STD Grey Static Dissipative 1709-BR White DELRIN 500 • Fine Angulated SMD Flat Tip</p>	<p>115 mm - 4 1/2" 115 mm - 4 1/2" 115 mm - 4 1/2"</p>	 <p>* 1.5 mm - .06"</p>	
<p>1610A-BR Black ESD Safe 1610A-BR-STD Grey Static Dissipative 1710A-BR White DELRIN 500 • Very Small Fine Angulated SMD Flat Tip</p>	<p>115 mm - 4 1/2" 115 mm - 4 1/2" 115 mm - 4 1/2"</p>	 <p>* 0.6 mm - .023"</p>	
<p>1615-BR Black ESD Safe 1615-BR-STD Grey Static Dissipative 1715-BR White DELRIN 500 • Extra Fine Tip</p>	<p>120 mm - 4 3/4" 120 mm - 4 3/4" 120 mm - 4 3/4"</p>	 <p>* 0.3 mm - .011"</p>	
<p>1616-BR Black ESD Safe 1616-BR-STD Grey Static Dissipative 1716-BR White DELRIN 500 • Very Fine Tip</p>	<p>120 mm - 4 3/4" 120 mm - 4 3/4" 120 mm - 4 3/4"</p>	 <p>* 0.5 mm - .019"</p>	
<p>1617-BR Black ESD Safe 1617-BR-STD Grey Static Dissipative 1717-BR White DELRIN 500 • Flat Tip</p>	<p>120 mm - 4 3/4" 120 mm - 4 3/4" 120 mm - 4 3/4"</p>	 <p>* 1.5 mm - .06"</p>	
<p>1617B-BR Black ESD Safe 1617B-BR-STD Grey Static Dissipative 1717B-BR White DELRIN 500 • Curved Flat Tip</p>	<p>120 mm - 4 3/4" 120 mm - 4 3/4" 120 mm - 4 3/4"</p>	 <p>* 1.5 mm - .06"</p>	
<p>1618-BR Black ESD Safe 1618-BR-STD Grey Static Dissipative 1718-BR White DELRIN 500 • For Handling and Positioning Quad Packs and Flat Parts</p>	<p>120 mm - 4 3/4" 120 mm - 4 3/4" 120 mm - 4 3/4"</p>	 <p>groove Ø 1 mm - .04"</p>	
<p>1624-BR Black ESD Safe 1624-BR-STD Grey Static Dissipative 1724-BR White DELRIN 500 • Very Fine Angulated Flat Tip</p>	<p>120 mm - 4 3/4" 120 mm - 4 3/4" 120 mm - 4 3/4"</p>	 <p>* 0.5 mm - .019"</p>	

QUICK CHANGE TWEEZERS - 1800-SA / 1800-SA-STD / 1900-SA series
Stainless Antiacid Antimagnetic Handle



Made in Switzerland
Patented



1800-SA series with Black ESD Safe Tip
1800-SA-STD series with Grey Static Dissipative Tip
1900-SA series with White DELRIN 500 Tip

- Available with Patented EZ Lever, add suffix "-EZ" (example 1802-SA-EZ)
- Available with Inside Serrated Tip, add suffix "D" (example 1802D-SA)

<p>1802-SA Black ESD Safe</p> <p>1802-SA-STD Grey Static Dissipative</p> <p>1902-SA White DELRIN 500</p> <ul style="list-style-type: none"> • MediumTip 	<p>135 mm - 5 1/4"</p> <p>135 mm - 5 1/4"</p> <p>135 mm - 5 1/4"</p>	<p>* 2 mm - .08"</p>	
<p>1803-SA Black ESD Safe</p> <p>1803-SA-STD Grey Static Dissipative</p> <p>1903-SA White DELRIN 500</p> <ul style="list-style-type: none"> • Strong Flat Tip 	<p>127 mm - 5"</p> <p>127 mm - 5"</p> <p>127 mm - 5"</p>	<p>* 2.3 mm - .09"</p>	
<p>1804-SA Black ESD Safe</p> <p>1804-SA-STD Grey Static Dissipative</p> <p>1904-SA White DELRIN 500</p> <ul style="list-style-type: none"> • Fine Tip 	<p>135 mm - 5 1/4"</p> <p>135 mm - 5 1/4"</p> <p>135 mm - 5 1/4"</p>	<p>* 0.6 mm - .023"</p>	
<p>1804B-SA Black ESD Safe</p> <p>1804B-SA-STD Grey Static Dissipative</p> <p>1904B-SA White DELRIN 500</p> <ul style="list-style-type: none"> • Curved Fine Tip 	<p>135 mm - 5 1/4"</p> <p>135 mm - 5 1/4"</p> <p>135 mm - 5 1/4"</p>	<p>* 0.6 mm - .023"</p>	
<p>1806-SA Black ESD Safe</p> <p>1806-SA-STD Grey Static Dissipative</p> <p>1906-SA White DELRIN 500</p> <ul style="list-style-type: none"> • Strong Angulated SMD Flat Tip 	<p>135 mm - 5 1/4"</p> <p>135 mm - 5 1/4"</p> <p>135 mm - 5 1/4"</p>	<p>* 2.5 mm - .1"</p>	

QUICK CHANGE TWEEZERS - 1800-SA / 1800-SA-STD / 1900-SA series



Made in Switzerland
Patented

Stainless Antiacid Antimagnetic Handle

- Available with Patented EZ Lever, add suffix "-EZ" (example 1809-SA-EZ)
- Available with Inside Serrated Tip, add suffix "D" (example 1809D-SA)

<p>1809-SA Black ESD Safe 1809-SA-STD Grey Static Dissipative 1909-SA White DELRIN 500 • Fine Angulated SMD Flat Tip</p>	<p>127 mm - 5" 127 mm - 5" 127 mm - 5"</p>	 * 1.5 mm - .06"	
<p>1810A-SA Black ESD Safe 18010A-SA-STD Grey Static Dissipative 1910A-SA White DELRIN 500 • Very Small Fine Angulated SMD Flat Tip</p>	<p>127 mm - 5" 127 mm - 5" 127 mm - 5"</p>	 * 0.6 mm - .023"	
<p>1815-SA Black ESD Safe 1815-SA-STD Grey Static Dissipative 1915-SA White DELRIN 500 • Extra Fine Tip</p>	<p>135 mm - 5 1/4" 135 mm - 5 1/4" 135 mm - 5 1/4"</p>	 * 0.3 mm - .011"	
<p>1816-SA Black ESD Safe 1816-SA-STD Grey Static Dissipative 1916-SA White DELRIN 500 • Very Fine Tip</p>	<p>135 mm - 5 1/4" 135 mm - 5 1/4" 135 mm - 5 1/4"</p>	 * 0.5 mm - .019"	
<p>1817-SA Black ESD Safe 1817-SA-STD Grey Static Dissipative 1917-SA White DELRIN 500 • Flat Tip</p>	<p>135 mm - 5 1/4" 135 mm - 5 1/4" 135 mm - 5 1/4"</p>	 * 1.5 mm - .06"	
<p>1817B-SA Black ESD Safe 1817B-SA-STD Grey Static Dissipative 1917B-SA White DELRIN 500 • Curved Flat Tip</p>	<p>135 mm - 5 1/4" 135 mm - 5 1/4" 135 mm - 5 1/4"</p>	 * 1.5 mm - .06"	
<p>1818-SA Black ESD Safe 1818-SA-STD Grey Static Dissipative 1918-SA White DELRIN 500 • For Handling and Positioning Quad Packs and Flat Parts</p>	<p>135 mm - 5 1/4" 135 mm - 5 1/4" 135 mm - 5 1/4"</p>	 groove Ø 1 mm - .04"	
<p>1824-SA Black ESD Safe 1824-SA-STD Grey Static Dissipative 1924-SA White DELRIN 500 • Very Fine Angulated Flat Tip</p>	<p>135 mm - 5 1/4" 135 mm - 5 1/4" 135 mm - 5 1/4"</p>	 * 0.5 mm - .019"	

QUICK CHANGE TWEEZERS - 1800-AL / 1800AL-STD / 1900-AL series

Aluminum Handle



Made in Switzerland
Patented



1804-AL



1904-AL



1804-AL-STD

1800-AL series with Black ESD Safe Tip
1800AL-STD series with Grey Static Dissipative Tip
1900-AL series with White DELRIN 500 Tip

- Available with Patented EZ Lever, add suffix "-EZ" (example 1802-AL-EZ)
- Available with Inside Serrated Tip, add suffix "D" (example 1802D-AL)

<p>1802-AL Black ESD Safe</p> <p>1802-AL-STD Grey Static Dissipative</p> <p>1902-AL White DELRIN 500</p> <ul style="list-style-type: none"> • MediumTip 	<p>135 mm - 5 1/4"</p> <p>135 mm - 5 1/4"</p> <p>135 mm - 5 1/4"</p>	<p>* 2 mm - .08"</p>	
<p>1803-AL Black ESD Safe</p> <p>1803-AL-STD Grey Static Dissipative</p> <p>1903-AL White DELRIN 500</p> <ul style="list-style-type: none"> • Strong Flat Tip 	<p>127 mm - 5"</p> <p>127 mm - 5"</p> <p>127 mm - 5"</p>	<p>* 2.3 mm - .09"</p>	
<p>1804-AL Black ESD Safe</p> <p>1804-AL-STD Grey Static Dissipative</p> <p>1904-AL White DELRIN 500</p> <ul style="list-style-type: none"> • Fine Tip 	<p>135 mm - 5 1/4"</p> <p>135 mm - 5 1/4"</p> <p>135 mm - 5 1/4"</p>	<p>* 0.6 mm - .023"</p>	
<p>1804B-AL Black ESD Safe</p> <p>1804B-AL-STD Grey Static Dissipative</p> <p>1904B-AL White DELRIN 500</p> <ul style="list-style-type: none"> • Curved Fine Tip 	<p>135 mm - 5 1/4"</p> <p>135 mm - 5 1/4"</p> <p>135 mm - 5 1/4"</p>	<p>* 0.6 mm - .023"</p>	
<p>1806-AL Black ESD Safe</p> <p>1806-AL-STD Grey Static Dissipative</p> <p>1906-AL White DELRIN 500</p> <ul style="list-style-type: none"> • Strong Angulated SMD Flat Tip 	<p>135 mm - 5 1/4"</p> <p>135 mm - 5 1/4"</p> <p>135 mm - 5 1/4"</p>	<p>* 2.5 mm - .1"</p>	

















QUICK CHANGE TWEEZERS - 1800-AL / 1800-AL-STD / 1900-AL series

Aluminum Handle

- Available with Patented EZ Lever, add suffix "-EZ" (example 1809-AL-EZ)
- Available with Inside Serrated Tip, add suffix "D" (example 1809D-AL)



Made in Switzerland
Patented

<p>1809-AL Black ESD Safe 1809-AL-STD Grey Static Dissipative 1909-AL White DELRIN 500 • Fine Angulated SMD Flat Tip</p>	<p>127 mm - 5" 127 mm - 5" 127 mm - 5"</p>	 <p>* 1.5 mm - .06"</p>	
<p>1810A-AL Black ESD Safe 1810A-AL-STD Grey Static Dissipative 1910A-AL White DELRIN 500 • Very Small Fine Angulated SMD Flat Tip</p>	<p>127 mm - 5" 127 mm - 5" 127 mm - 5"</p>	 <p>* 0.6 mm - .023"</p>	
<p>1815-AL Black ESD Safe 1815-AL-STD Grey Static Dissipative 1915-AL White DELRIN 500 • Extra Fine Tip</p>	<p>135 mm - 5 1/4" 135 mm - 5 1/4" 135 mm - 5 1/4"</p>	 <p>* 0.3 mm - .011"</p>	
<p>1816-AL Black ESD Safe 1816-AL-STD Grey Static Dissipative 1916-AL White DELRIN 500 • Very Fine Tip</p>	<p>135 mm - 5 1/4" 135 mm - 5 1/4" 135 mm - 5 1/4"</p>	 <p>* 0.5 mm - .019"</p>	
<p>1817-AL Black ESD Safe 1817-AL-STD Grey Static Dissipative 1917-AL White DELRIN 500 • Flat Tip</p>	<p>135 mm - 5 1/4" 135 mm - 5 1/4" 135 mm - 5 1/4"</p>	 <p>* 1.5 mm - .06"</p>	
<p>1817B-AL Black ESD Safe 1817B-AL-STD Grey Static Dissipative 1917B-AL White DELRIN 500 • Curved Flat Tip</p>	<p>135 mm - 5 1/4" 135 mm - 5 1/4" 135 mm - 5 1/4"</p>	 <p>* 1.5 mm - .06"</p>	
<p>1818-AL Black ESD Safe 1818-AL-STD Grey Static Dissipative 1918-AL White DELRIN 500 • For Handling and Positioning Quad Packs and Flat Parts</p>	<p>135 mm - 5 1/4" 135 mm - 5 1/4" 135 mm - 5 1/4"</p>	 <p>groove Ø 1 mm - .04"</p>	
<p>1824-AL Black ESD Safe 1824-AL-STD Grey Static Dissipative 1924-AL White DELRIN 500 • Very Fine Angulated Flat Tip</p>	<p>135 mm - 5 1/4" 135 mm - 5 1/4" 135 mm - 5 1/4"</p>	 <p>* 0.5 mm - .019"</p>	

QUICK CHANGE TWEEZERS - 1800-BR / 1800-BR-STD / 1900-BR series

Brass Handle



Made in Switzerland
Patented



1800-BR series with Black ESD Safe Tip
1800-BR-STD series with Grey Static Dissipative Tip
1900-BR series with White DELRIN 500 Tip

- Available with Patented EZ Lever, add suffix "-EZ" (example 1802-BR-EZ)
- Available with Inside Serrated Tip, add suffix "D" (example 1802D-BR)

<p>1802-BR Black ESD Safe</p> <p>1802-BR-STD Grey Static Dissipative</p> <p>1902-BR White DELRIN 500</p> <ul style="list-style-type: none"> • MediumTip 	<p>135 mm - 5 1/4"</p> <p>135 mm - 5 1/4"</p> <p>135 mm - 5 1/4"</p>	<p>* 2 mm - .08"</p>	
<p>1803-BR Black ESD Safe</p> <p>1803-BR-STD Grey Static Dissipative</p> <p>1903-BR White DELRIN 500</p> <ul style="list-style-type: none"> • Strong Flat Tip 	<p>127 mm - 5"</p> <p>127 mm - 5"</p> <p>127 mm - 5"</p>	<p>* 2.3 mm - .09"</p>	
<p>1804-BR Black ESD Safe</p> <p>1804-BR-STD Grey Static Dissipative</p> <p>1904-BR White DELRIN 500</p> <ul style="list-style-type: none"> • Fine Tip 	<p>135 mm - 5 1/4"</p> <p>135 mm - 5 1/4"</p> <p>135 mm - 5 1/4"</p>	<p>* 0.6 mm - .023"</p>	
<p>1804B-BR Black ESD Safe</p> <p>1804B-BR-STD Grey Static Dissipative</p> <p>1904B-BR White DELRIN 500</p> <ul style="list-style-type: none"> • Curved Fine Tip 	<p>135 mm - 5 1/4"</p> <p>135 mm - 5 1/4"</p> <p>135 mm - 5 1/4"</p>	<p>* 0.6 mm - .023"</p>	
<p>1806-BR Black ESD Safe</p> <p>1806-BR-STD Grey Static Dissipative</p> <p>1906-BR White DELRIN 500</p> <ul style="list-style-type: none"> • Strong Angulated SMD Flat Tip 	<p>135 mm - 5 1/4"</p> <p>135 mm - 5 1/4"</p> <p>135 mm - 5 1/4"</p>	<p>* 2.5 mm - .1"</p>	

QUICK CHANGE TWEEZERS - 1800-BR / 1800-BR-STD / 1900-BR series



Made in Switzerland
Patented

Brass Handle

- Available with Patented EZ Lever, add suffix "-EZ" (example 1809-BR-EZ)
- Available with Inside Serrated Tip, add suffix "D" (example 1809D-BR)

<p>1809-BR Black ESD Safe 1809-BR-STD Grey Static Dissipative 1909-BR White DELRIN 500 • Fine Angulated SMD Flat Tip</p>	<p>127 mm - 5"</p> <p>127 mm - 5"</p> <p>127 mm - 5"</p>	<p>* 1.5 mm - .06"</p>	
<p>1810A-BR Black ESD Safe 1810A-BR-STD Grey Static Dissipative 1910A-BR White DELRIN 500 • Very Small Fine Angulated SMD Flat Tip</p>	<p>127 mm - 5"</p> <p>127 mm - 5"</p> <p>127 mm - 5"</p>	<p>* 0.6 mm - .023"</p>	
<p>1815-BR Black ESD Safe 1815-BR-STD Grey Static Dissipative 1915-BR White DELRIN 500 • Extra Fine Tip</p>	<p>135 mm - 5 1/4"</p> <p>135 mm - 5 1/4"</p> <p>135 mm - 5 1/4"</p>	<p>* 0.3 mm - .011"</p>	
<p>1816-BR Black ESD Safe 1816-BR-STD Grey Static Dissipative 1916-BR White DELRIN 500 • Very Fine Tip</p>	<p>135 mm - 5 1/4"</p> <p>135 mm - 5 1/4"</p> <p>135 mm - 5 1/4"</p>	<p>* 0.5 mm - .019"</p>	
<p>1817-BR Black ESD Safe 1817-BR-STD Grey Static Dissipative 1917-BR White DELRIN 500 • Flat Tip</p>	<p>135 mm - 5 1/4"</p> <p>135 mm - 5 1/4"</p> <p>135 mm - 5 1/4"</p>	<p>* 1.5 mm - .06"</p>	
<p>1817B-BR Black ESD Safe 1817B-BR-STD Grey Static Dissipative 1917B-BR White DELRIN 500 • Curved Flat Tip</p>	<p>135 mm - 5 1/4"</p> <p>135 mm - 5 1/4"</p> <p>135 mm - 5 1/4"</p>	<p>* 1.5 mm - .06"</p>	
<p>1818-BR Black ESD Safe 1818-BR-STD Grey Static Dissipative 1918-BR White DELRIN 500 • For Handling and Positioning Quad Packs</p>	<p>135 mm - 5 1/4"</p> <p>135 mm - 5 1/4"</p> <p>135 mm - 5 1/4"</p>	<p>groove Ø 1 mm - .04"</p>	
<p>1824-BR Black ESD Safe 1824-BR-STD Grey Static Dissipative 1924-BR White DELRIN 500 • Very Fine Angulated Flat Tip</p>	<p>135 mm - 5 1/4"</p> <p>135 mm - 5 1/4"</p> <p>135 mm - 5 1/4"</p>	<p>* 0.5 mm - .019"</p>	

QUICK CHANGE TWEEZERS - 1300C-SA / 1300C-SA-STD / 1400C-SA series

Stainless Antiacid Antimagnetic Short Handle



Made in Switzerland
Patented



1300C-SA series with Black ESD Safe Tip
1300C-SA-STD series with Grey Static Dissipative Tip
1400-SA series with White DELRIN 500 Tip

- Available in Reverse Action, add prefix "R" (example R1302C-SA)
- Available with Patented EZ Lever, add suffix "-EZ" (example 1302C-SA-EZ)
- Available with Inside Serrated Tip, add suffix "D" (example 1302CD-SA)

<p>1302C-SA Black ESD Safe</p> <p>1302C-SA-STD Grey Static Dissipative</p> <p>1402C-SA White DELRIN 500</p> <ul style="list-style-type: none"> • MediumTip 	<p>110 mm - 4 1/3"</p> <p>110 mm - 4 1/3"</p> <p>110 mm - 4 1/3"</p>	<p>* 2 mm - .08"</p>	
<p>1303C-SA Black ESD Safe</p> <p>1303C-SA-STD Grey Static Dissipative</p> <p>1403C-SA White DELRIN 500</p> <ul style="list-style-type: none"> • Strong Flat Tip 	<p>105 mm - 4 1/6"</p> <p>105 mm - 4 1/6"</p> <p>105 mm - 4 1/6"</p>	<p>* 2.3 mm - .09"</p>	
<p>1304C-SA Black ESD Safe</p> <p>1304C-SA-STD Grey Static Dissipative</p> <p>1404C-SA White DELRIN 500</p> <ul style="list-style-type: none"> • Fine Tip 	<p>110 mm - 4 1/3"</p> <p>110 mm - 4 1/3"</p> <p>110 mm - 4 1/3"</p>	<p>* 0.6 mm - .023"</p>	
<p>1304BC-SA Black ESD Safe</p> <p>1304BC-SA-STD Grey Static Dissipative</p> <p>1404BC-SA White DELRIN 500</p> <ul style="list-style-type: none"> • Curved Fine Tip 	<p>110 mm - 4 1/3"</p> <p>110 mm - 4 1/3"</p> <p>110 mm - 4 1/3"</p>	<p>* 0.6 mm - .023"</p>	
<p>1306C-SA Black ESD Safe</p> <p>1306C-SA-STD Grey Static Dissipative</p> <p>1406C-SA White DELRIN 500</p> <ul style="list-style-type: none"> • Strong Angulated SMD Flat Tip 	<p>110 mm - 4 1/3"</p> <p>110 mm - 4 1/3"</p> <p>110 mm - 4 1/3"</p>	<p>* 2.5 mm - .1"</p>	

















QUICK CHANGE TWEEZERS - 1300C-SA / 1300C-SA-STD / 1400C-SA series



Made in Switzerland
Patented

Stainless Antiacid Antimagnetic Short Handle

- Available in Reverse Action, add prefix "R" (example R1309C-SA)
- Available with Patented EZ Lever, add suffix "-EZ" (example 1309C-SA-EZ)
- Available with Inside Serrated Tip, add suffix "D" (example 1309CD-SA)

<p>1309C-SA Black ESD Safe 1309C-SA-STD Grey Static Dissipative 1409C-SA White DELRIN 500 • Fine Angulated SMD Flat Tip</p>	<p>105 mm - 4 1/6" 105 mm - 4 1/6" 105 mm - 4 1/6"</p>	 * 1.5 mm - .06"	
<p>1310AC-SA Black ESD Safe 1310AC-SA-STD Grey Static Dissipative 1410AC-SA White DELRIN 500 • Very Small Fine Angulated SMD Flat Tip</p>	<p>105 mm - 4 1/6" 105 mm - 4 1/6" 105 mm - 4 1/6"</p>	 * 0.6 mm - .023"	
<p>1315C-SA Black ESD Safe 1315C-SA-STD Grey Static Dissipative 1415C-SA White DELRIN 500 • Extra Fine Tip</p>	<p>110 mm - 4 1/3" 110 mm - 4 1/3" 110 mm - 4 1/3"</p>	 * 0.3 mm - .011"	
<p>1316C-SA Black ESD Safe 1316C-SA-STD Grey Static Dissipative 1416C-SA White DELRIN 500 • Very Fine Tip</p>	<p>110 mm - 4 1/3" 110 mm - 4 1/3" 110 mm - 4 1/3"</p>	 * 0.5 mm - .019"	
<p>1317C-SA Black ESD Safe 1317C-SA-STD Grey Static Dissipative 1417C-SA White DELRIN 500 • Flat Tip</p>	<p>110 mm - 4 1/3" 110 mm - 4 1/3" 110 mm - 4 1/3"</p>	 * 1.5 mm - .06"	
<p>1317BC-SA Black ESD Safe 1317BC-SA-STD Grey Static Dissipative 1417BC-SA White DELRIN 500 • Curved Flat Tip</p>	<p>110 mm - 4 1/3" 110 mm - 4 1/3" 110 mm - 4 1/3"</p>	 * 1.5 mm - .06"	
<p>1318C-SA Black ESD Safe 1318C-SA-STD Grey Static Dissipative 1418C-SA White DELRIN 500 • For Handling and Positioning Quad Packs and Flat Parts</p>	<p>110 mm - 4 1/3" 110 mm - 4 1/3" 110 mm - 4 1/3"</p>	 groove Ø 1 mm - .04"	
<p>1324C-SA Black ESD Safe 1324C-SA-STD Grey Static Dissipative 1424C-SA White DELRIN 500 • Very Fine Angulated Flat Tip</p>	<p>110 mm - 4 1/3" 110 mm - 4 1/3" 110 mm - 4 1/3"</p>	 * 0.5 mm - .019"	

QUICK CHANGE Lead Straightener and Wafer Handling Tweezers

Stainless Antiacid Antimagnetic Handle

- Available in Reverse Action, add prefix "R" (example RT5508-SA)



Made in Switzerland
Patented

<p>T5508-SA 125 mm - 5" Black ESD Safe T5508-SA-STD 125 mm - 5" Grey Static Dissipative T5608-SA 125 mm - 5" White DELRIN 500 • DIP / IC / QFP Pin Straightener</p>		
<p>T5531-SA 130 mm - 5 1/8" Black ESD Safe T5531-SA-STD 130 mm - 5 1/8" Grey Static Dissipative T5631-SA 130 mm - 5 1/8" White DELRIN 500 • Lead Straightener</p>		
<p>1390W-SA 115 mm - 4 1/2" Black ESD Safe 1390W-SA-STD 115 mm - 4 1/2" Grey Static Dissipative 1490W-SA 115 mm - 4 1/2" White DELRIN 500 • Wafer Handling Tweezers, for 2 1/2" up to 5" Wafers</p>		
<p>T5508W-SA 130 mm - 5 1/8" Black ESD Safe T5508W-SA-STD 130 mm - 5 1/8" Grey Static Dissipative T5608W-SA 130 mm - 5 1/8" White DELRIN 500 • Wafer Handling Tweezers, for 3" up to 8" Wafers</p>		
<p>T5509W-SA 135 mm - 5 1/4" Black ESD Safe T5509W-SA-STD 135 mm - 5 1/4" Grey Static Dissipative T5609W-SA 135 mm - 5 1/4" White DELRIN 500 • Wafer Handling Tweezers, for 6" up to 10" Wafers</p>		
<p>T5510W-SA 145 mm - 5 3/4" Black ESD Safe T5510W-SA-STD 145 mm - 5 3/4" Grey Static Dissipative T5610W-SA 145 mm - 5 3/4" White DELRIN 500 • Wafer Handling Tweezers, for 10" up to 15" Wafers</p>		

QUICK CHANGE Wafer and CD Handling Tweezers

With Multi Directional SWIVEL TIP
 For Right or Left Handed Operator
 Stainless Antiacid Antimagnetic Handle



Made in Switzerland
 Patented

- | | |
|---|-----------------|
| MD-1390W-SA
Black ESD Safe | 140 mm – 5 1/2" |
| MD-1390W-SA-STD
Grey Static Dissipative | 140 mm – 5 1/2" |
| MD-1490W-SA
White DELRIN 500 | 140 mm – 5 1/2" |
| • Wafer Handling Tweezers, for 2 1/2" up to 5" Wafers | |
| MD-5508W-SA
Black ESD Safe | 135 mm – 5 1/4" |
| MD-5508W-SA-STD
Grey Static Dissipative | 135 mm – 5 1/4" |
| MD-5608W-SA
White DELRIN 500 | 135 mm – 5 1/4" |
| • Wafer Handling Tweezers, for 3" up to 8" Wafers | |
| MD-5509W-SA
Black ESD Safe | 140 mm – 5 1/2" |
| MD-5509W-SA-STD
Grey Static Dissipative | 140 mm – 5 1/2" |
| MD-5609W-SA
White DELRIN 500 | 140 mm – 5 1/2" |
| • Wafer Handling Tweezers, for 6" up to 10" Wafers | |
| MD-5510W-SA
Black ESD Safe | 145 mm – 5 3/4" |
| MD-5510W-SA-STD
Grey Static Dissipative | 145 mm – 5 3/4" |
| MD-5610W-SA
White DELRIN 500 | 145 mm – 5 3/4" |
| • Wafer Handling Tweezers, for 10" up to 15" Wafers | |

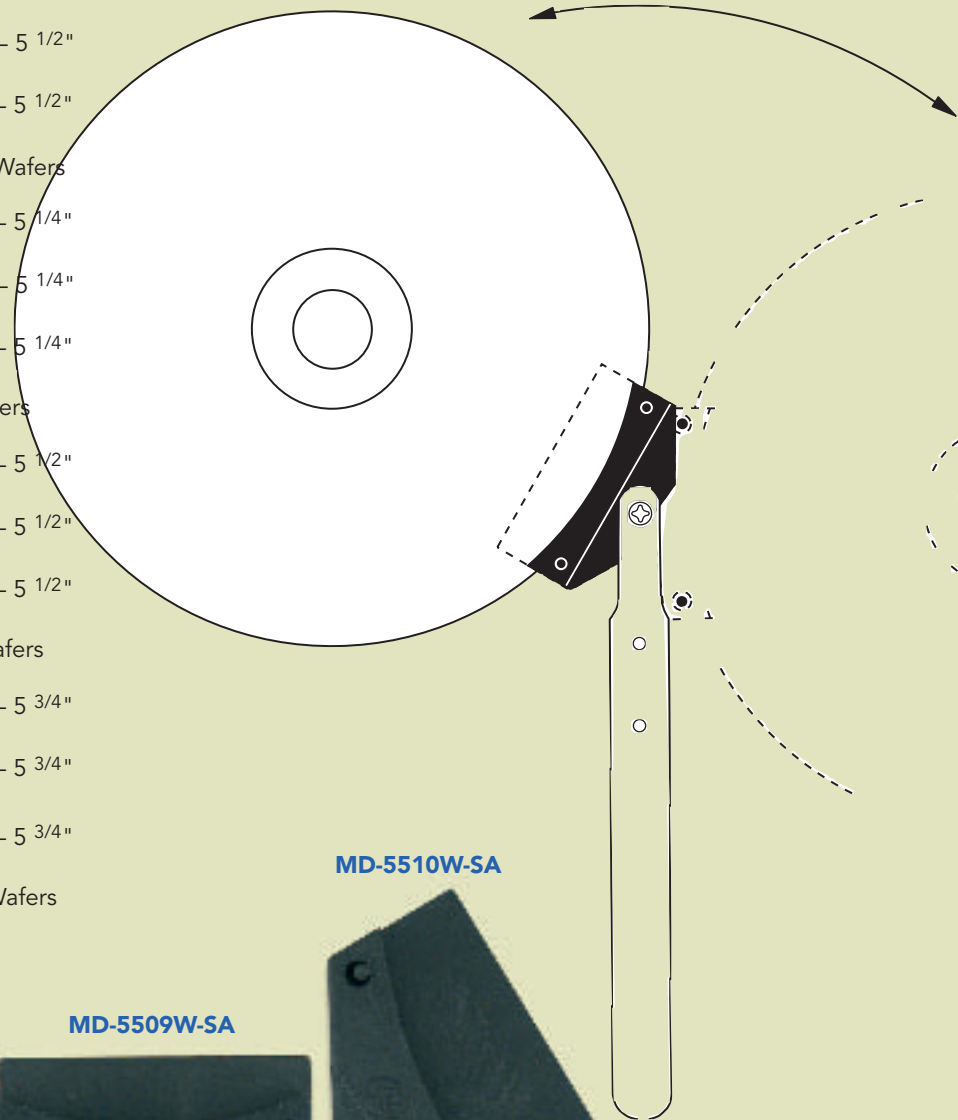

New Concept of Rotating Tip, for Handling Wafers or CDs from any Angle, with Patented EZ Lever, for Better Access, Better Visibility, more Comfort and Safety.

To order Replacement Tip, add Prefix **TIP-...** to the Part Number
 Example: **TIP-MD-1390W**
TIP-MD-5510W

QUICK CHANGE TWEEZERS with 45° BENT Handle



Made in Switzerland
Patented

- Stainless Antiacid Antimagnetic Bent Handle, add suffix "-BSA"
- Aluminum Bent Handle, add suffix "-BAL"
- Brass Bent Handle, add suffix "-BBR"
- 1300 series with Black ESD Safe Tip
- 1300-STD-series with Grey Static Dissipative Tip
- 1400 series with White DELRIN 500 Tip

Available with inside Serrated Tip, add suffix "D" (example 1302D-BSA)











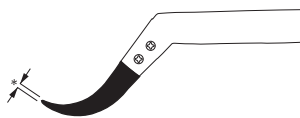

<p>1302-BSA 1302-BAL 1302-BBR Black ESD Safe 1402-BSA 1402-BAL 1402-BBR White DELRIN 500 • Medium Tip</p>	<p>110 mm – 4 1/3"</p>	<p>* 2 mm -.08"</p>	
<p>1303-BSA 1303-BAL 1303-BBR Black ESD Safe 1403-BSA 1403-BAL 1403-BBR White DELRIN 500 • Strong Flat Tip</p>	<p>105 mm – 4 1/6"</p>	<p>* 2.3 mm -.09"</p>	
<p>1304-BSA 1304-BAL 1304-BBR Black ESD Safe 1404-BSA 1404-BAL 1404-BBR White DELRIN 500 • Fine Tip</p>	<p>110 mm – 4 1/3"</p>	<p>* 0.6 mm -.023"</p>	

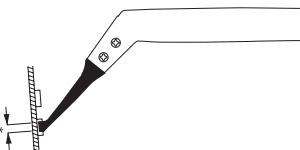
QUICK CHANGE TWEEZERS with 45° BENT Handle

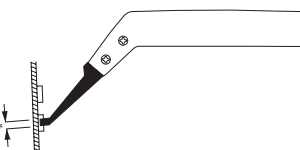

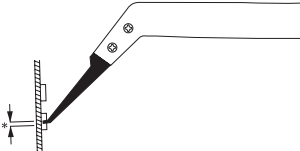
Made in Switzerland
Patented

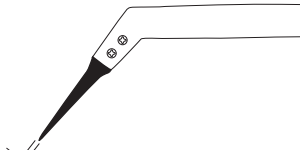
- Stainless Antiacid Antimagnetic Bent Handle, add suffix "-BSA"
- Aluminum Bent Handle, add suffix "-BAL"
- Brass Bent Handle, add suffix "-BBR"
- 1300 series with Black ESD Safe Tip
- 1300-STD series with Grey Static Dissipative Tip
- 1400 series with White DELRIN 500 Tip
- Available with Inside Serrated Tip, add suffix "D" (example 1309D-BSA)

<p>1304B-BSA 1304B-BAL 1304B-BBR Black ESD Safe 1404B-BSA 1404B-BAL 1404B-BBR White DELRIN 500 • Curved Fine Tip</p> <p>1304B-BSA-STD 1304B-BAL-STD 1304B-BBR-STD Grey Static Dissipative</p>	<p>110 mm – 4 1/3"</p>  <p>* 0.6 mm -.023"</p>	
<p>1306-BSA 1306-BAL 1306-BBR Black ESD Safe 1406-BSA 1406-BAL 1406-BBR White DELRIN 500 • Strong Angulated SMD Flat Tip</p> <p>1306-BSA-STD 1306-BAL-STD 1306-BBR-STD Grey Static Dissipative</p>	<p>110 mm – 4 1/3"</p>  <p>* 2.5 mm -.1"</p>	
<p>1309-BSA 1309-BAL 1309-BBR Black ESD Safe 1409-BSA 1409-BAL 1409-BBR White DELRIN 500 • Fine Angulated SMD Flat Tip</p> <p>1309-BSA-STD 1309-BAL-STD 1309-BBR-STD Grey Static Dissipative</p>	<p>105 mm – 4 1/6"</p>  <p>* 1.5 mm -.06"</p>	
<p>1310A-BSA 1310A-BAL 1310A-BBR Black ESD Safe 1410A-BSA 1410A-BAL 1410A-BBR White DELRIN 500 • Very Small Fine Angulated SMD Flat Tip</p> <p>1410A-BSA-STD 1410A-BAL-STD 1410A-BBR-STD Grey Static Dissipative</p>	<p>105 mm – 4 1/6"</p>  <p>* 0.6 mm -.023"</p>	
<p>1315-BSA 1315-BAL 1315-BBR Black ESD Safe 1415-BSA 1415-BAL 1415-BBR White DELRIN 500 • Extra Fine Tip</p> <p>1315-BSA-STD 1315-BAL-STD 1315-BBR-STD Grey Static Dissipative</p>	<p>110 mm – 4 1/3"</p>  <p>* 0.3 mm -.011"</p>	

QUICK CHANGE TWEEZERS with 45° BENT Handle



Made in Switzerland
Patented

- Stainless Antiacid Antimagnetic Bent Handle, add suffix "-BSA"
- Aluminum Bent Handle, add suffix "-BAL"
- Brass Bent Handle, add suffix "-BBR"
- 1300 series with Black ESD Safe Tip
- 1300-STD series with Grey Static Dissipative Tip
- 1400 series with White DELRIN 500 Tip
- Available with Inside Serrated Tip, add suffix "D" (example 1316D-BSA)

<p>1316-BSA 1316-BAL 1316-BBR Black ESD Safe 1416-BSA 1416-BAL 1416-BBR White DELRIN 500 • Very Fine Tip</p> <p>1316-BSA-STD 1316-BAL-STD 1316-BBR-STD Grey Static Dissipative</p>	<p>110 mm – 4 1/3"</p>	<p>* 0.5 mm -.019"</p>	
<p>1317-BSA 1317-BAL 1317-BBR Black ESD Safe 1417-BSA 1417-BAL 1417-BBR White DELRIN 500 • Flat Tip</p> <p>1317-BSA-STD 1317-BAL-STD 1317-BBR-STD Grey Static Dissipative</p>	<p>110 mm – 4 1/3"</p>	<p>* 1.5 mm -.06"</p>	
<p>1317B-BSA 1317B-BAL 1317B-BBR Black ESD Safe 1417B-BSA 1417B-BAL 1417B-BBR White DELRIN 500 • Curved Flat Tip</p> <p>1317B-BSA-STD 1317B-BAL-STD 1317B-BBR-STD Grey Static Dissipative</p>	<p>110 mm – 4 1/3"</p>	<p>* 1.5 mm -.06"</p>	
<p>1318-BSA 1318-BAL 1318-BBR Black ESD Safe 1418-BSA 1418-BAL 1418-BBR White DELRIN 500 • For Handling and Positioning Quad Packs and Flat Parts</p> <p>1318-BSA-STD 1318-BAL-STD 1318-BBR-STD Grey Static Dissipative</p>	<p>110 mm – 4 1/3"</p>	<p>groove Ø1 mm - .04"</p>	
<p>1324-BSA 1324-BAL 1324-BBR Black ESD Safe 1424-BSA 1424-BAL 1424-BBR White DELRIN 500 • Very Fine Angulated Flat Tip</p> <p>1324-BSA-STD 1324-BAL-STD 1324-BBR-STD Grey Static Dissipative</p>	<p>110 mm – 4 1/3"</p>	<p>* 0.5 mm -.019"</p>	







QUICK CHANGE TWEEZERS with 45° BENT Handle

- Stainless Antiacid Antimagnetic Serrated Bent Handle, add suffix "-BSA"
- Aluminum Serrated Bent Handle, add suffix "-BAL"
- Brass Serrated Bent Handle, add suffix "-BBR"
- 1600 series with Black ESD Safe Tip
- 1600-STD series with Grey Static Dissipative Tip
- 1700 series with White DELRIN 500 Tip
- Available with Inside Serrated Tip, add suffix "D" (example 1602D-BSA)

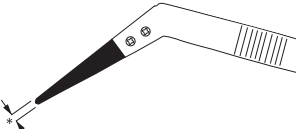

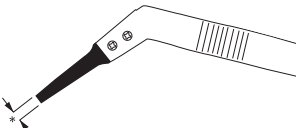
Made in Switzerland
Patented

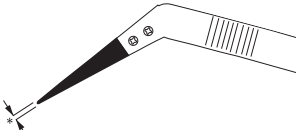









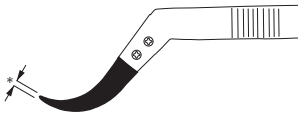

<p>1602-BSA 1602-BAL 1602-BBR Black ESD Safe 1702-BSA 1702-BAL 1702-BBR White DELRIN 500 • Medium Tip</p>	<p>110 mm – 4 1/3"</p>	 <p>* 2 mm -.08"</p>	
<p>1603-BSA 1603-BAL 1603-BBR Black ESD Safe 1703-BSA 1703-BAL 1703-BBR White DELRIN 500 • Strong Flat Tip</p>	<p>105 mm – 4 1/6"</p>	 <p>* 2.3 mm -.09"</p>	
<p>1604-BSA 1604-BAL 1604-BBR Black ESD Safe 1704-BSA 1704-BAL 1704-BBR White DELRIN 500 • Fine Tip</p>	<p>110 mm – 4 1/3"</p>	 <p>* 0.6 mm -.023"</p>	

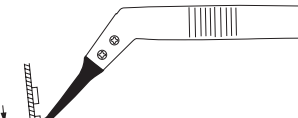
QUICK CHANGE TWEEZERS with 45° BENT Handle

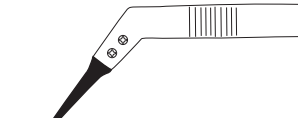

Made in Switzerland
Patented

- Stainless Antiacid Antimagnetic Serrated Bent Handle, add suffix "-BSA"
- Aluminum Serrated Bent Handle, add suffix "-BAL"
- Brass Serrated Bent Handle, add suffix "-BBR"
- 1600 series with Black ESD Safe Tip
- 1600-STD series with Grey Static Dissipative Tip
- 1700 series with White DELRIN 500 Tip
- Available with Inside Serrated Tip, add suffix "D" (example 1609D-BSA)









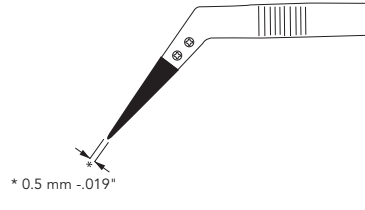

<p>1604B-BSA 1604B-BAL 1604B-BBR Black ESD Safe 1704B-BSA 1704B-BAL 1704B-BBR White DELRIN 500 • Curved Fine Tip</p>	<p>110 mm – 4 1/3"</p>	 <p>* 0.6 mm -.023"</p>	
<p>1606-BSA 1606-BAL 1606-BBR Black ESD Safe 1706-BSA 1706-BAL 1706-BBR White DELRIN 500 • Strong Angulated SMD Flat Tip</p>	<p>110 mm – 4 1/3"</p>	 <p>* 2.5 mm -.1"</p>	
<p>1609-BSA 1609-BAL 1609-BBR Black ESD Safe 1709-BSA 1709-BAL 1709-BBR White DELRIN 500 • Fine Angulated SMD Flat Tip</p>	<p>105 mm – 4 1/6"</p>	 <p>* 1.5 mm -.06"</p>	
<p>1610A-BSA 1610A-BAL 1610A-BBR Black ESD Safe 1710A-BSA 1710A-BAL 1710A-BBR White DELRIN 500 • Very Small Fine Angulated SMD Flat Tip</p>	<p>105 mm – 4 1/6"</p>	 <p>* 0.6 mm -.023"</p>	
<p>1615-BSA 1615-BAL 1615-BBR Black ESD Safe 1715-BSA 1715-BAL 1715-BBR White DELRIN 500 • Extra Fine Tip</p>	<p>110 mm – 4 1/3"</p>	 <p>* 0.3 mm -.011"</p>	

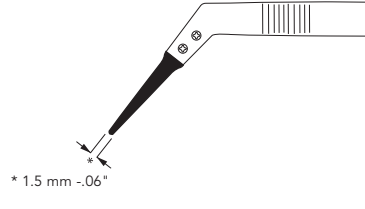
QUICK CHANGE TWEEZERS with 45° BENT Handle

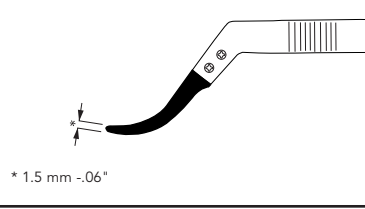

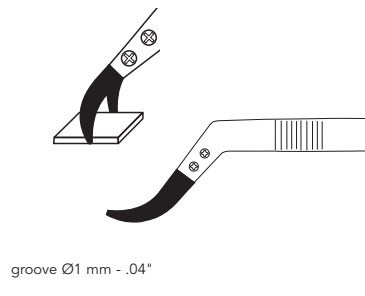
Made in Switzerland
Patented

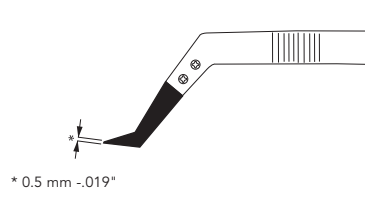
- Stainless Antiacid Antimagnetic Serrated Bent Handle, add suffix "-BSA"
- Aluminum Serrated Bent Handle, add suffix "-BAL"
- Brass Serrated Bent Handle, add suffix "-BBR"
- 1600 series with Black ESD Safe Tip
- 1600-STD series with Grey Static Dissipative Tip
- 1700 series with White DELRIN 500 Tip
- Available with Inside Serrated Tip, add suffix "D" (example 1616D-BSA)

<p>1616-BSA 1616-BAL 1616-BBR Black ESD Safe 1716-BSA 1716-BAL 1716-BBR White DELRIN 500 • Very Fine Tip</p>	<p>110 mm – 4 1/3"</p>	 <p>* 0.5 mm -.019"</p>	
<p>1617-BSA 1617-BAL 1617-BBR Black ESD Safe 1717-BSA 1717-BAL 1717-BBR White DELRIN 500 • Flat Tip</p>	<p>110 mm – 4 1/3"</p>	 <p>* 1.5 mm -.06"</p>	
<p>1617B-BSA 1617B-BAL 1617B-BBR Black ESD Safe 1717B-BSA 1717B-BAL 1717B-BBR White DELRIN 500 • Curved Flat Tip</p>	<p>110 mm – 4 1/3"</p>	 <p>* 1.5 mm -.06"</p>	
<p>1618-BSA 1618-BAL 1618-BBR Black ESD Safe 1718-BSA 1718-BAL 1718-BBR White DELRIN 500 • For Handling and Positioning Quad Packs and Flat Parts</p>	<p>110 mm – 4 1/3"</p>	 <p>groove Ø1 mm -.04"</p>	
<p>1624-BSA 1624-BAL 1624-BBR Black ESD Safe 1724-BSA 1724-BAL 1724-BBR White DELRIN 500 • Very Fine Angulated Flat Tip</p>	<p>110 mm – 4 1/3"</p>	 <p>* 0.5 mm -.019"</p>	

QUICK CHANGE TWEEZERS with 45° BENT Handle



Made in Switzerland
Patented

- Stainless Antiacid Antimagnetic Bent Handle, add suffix "-BSA"
- Aluminum Bent Handle, add suffix "-BAL"
- Brass Bent Handle, add suffix "-BBR"
- 1800 series with Black ESD Safe Tip
- 1800-STD series with Grey Static Dissipative Tip
- 1900 series with White DELRIN 500 Tip
- Available with Inside Serrated Tip, add suffix "D" (example 1802D-BSA)









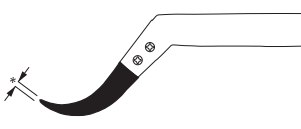

<p>1802-BSA 1802-BAL 1802-BBR Black ESD Safe 1902-BSA 1902-BAL 1902-BBR White DELRIN 500 • Medium Tip</p>	<p>120 mm – 4 3/4"</p>	<p>* 2 mm -.08"</p>	
<p>1803-BSA 1803-BAL 1803-BBR Black ESD Safe 1903-BSA 1903-BAL 1903-BBR White DELRIN 500 • Strong Flat Tip</p>	<p>115 mm – 4 1/2"</p>	<p>* 2.3 mm -.09"</p>	
<p>1804-BSA 1804-BAL 1804-BBR Black ESD Safe 1904-BSA 1904-BAL 1904-BBR White DELRIN 500 • Fine Tip</p>	<p>120 mm – 4 3/4"</p>	<p>* 0.6 mm -.023"</p>	

QUICK CHANGE TWEEZERS with 45° BENT Handle

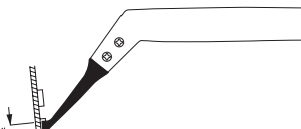
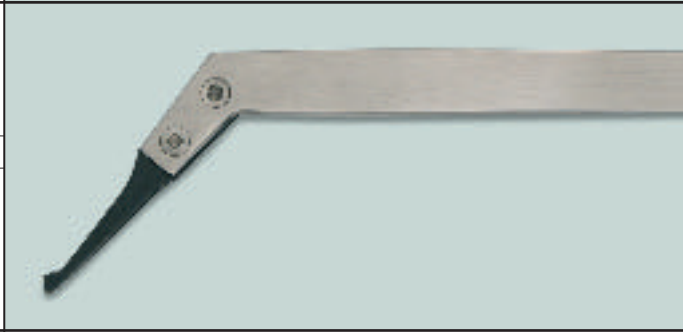
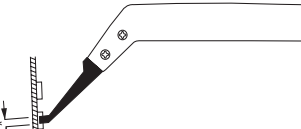

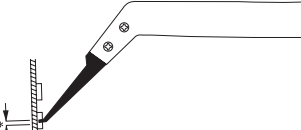
Made in Switzerland
Patented

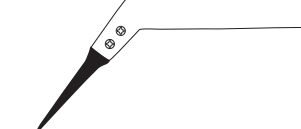
- Stainless Antiacid Antimagnetic Bent Handle, add suffix "-BSA"
- Aluminum Bent Handle, add suffix "-BAL"
- Brass Bent Handle, add suffix "-BBR"
- 1800 series with Black ESD Safe Tip
- 1800-STD series with Grey Static Dissipative Tip
- 1900 series with White DELRIN 500 Tip
- Available with Inside Serrated Tip, add suffix "D" (example 1809D-BSA)

<p>1804B-BSA 1804B-BAL 1804B-BBR Black ESD Safe</p> <p>1904B-BSA 1904B-BAL 1904B-BBR White DELRIN 500</p> <p>• Curved Fine Tip</p>	<p>120 mm – 4 3/4"</p>  <p>* 0.6 mm -.023"</p>	
<p>1806-BSA 1806-BAL 1806-BBR Black ESD Safe</p> <p>1906-BSA 1906-BAL 1906-BBR White DELRIN 500</p> <p>• Strong Angulated SMD Flat Tip</p>	<p>120 mm – 4 3/4"</p>  <p>* 2.5 mm -.1"</p>	
<p>1809-BSA 1809-BAL 1809-BBR Black ESD Safe</p> <p>1909-BSA 1909-BAL 1909-BBR White DELRIN 500</p> <p>• Fine Angulated SMD Flat Tip</p>	<p>115 mm – 4 1/2"</p>  <p>* 1.5 mm -.06"</p>	
<p>1810A-BSA 1810A-BAL 1810A-BBR Black ESD Safe</p> <p>1910A-BSA 1910A-BAL 1910A-BBR White DELRIN 500</p> <p>• Very Small Fine Angulated SMD Flat Tip</p>	<p>115 mm – 4 1/2"</p>  <p>* 0.6 mm -.023"</p>	
<p>1815-BSA 1815-BAL 1815-BBR Black ESD Safe</p> <p>1915-BSA 1915-BAL 1915-BBR White DELRIN 500</p> <p>• Extra Fine Tip</p>	<p>120 mm – 4 3/4"</p>  <p>* 0.3 mm -.011"</p>	

QUICK CHANGE TWEEZERS with 45° BENT Handle



Made in Switzerland
Patented

- Stainless Antiacid Antimagnetic Bent Handle, add suffix "-BSA"
- Aluminum Bent Handle, add suffix "-BAL"
- Brass Bent Handle, add suffix "-BBR"
- 1800 series with Black ESD Safe Tip
- 1800-STD series with Grey Static Dissipative Tip
- 1900 series with White DELRIN 500 Tip
- Available with Inside Serrated Tip, add suffix "D" (example 1816D-BSA)

<p>1816-BSA 1816-BAL 1816-BBR Black ESD Safe 1916-BSA 1916-BAL 1916-BBR White DELRIN 500 • Very Fine Tip</p>	<p>120 mm – 4 3/4"</p>	 <p>* 0.5 mm -.019"</p>	
<p>1817-BSA 1817-BAL 1817-BBR Black ESD Safe 1917-BSA 1917-BAL 1917-BBR White DELRIN 500 • Flat Tip</p>	<p>120 mm – 4 3/4"</p>	 <p>* 1.5 mm -.06"</p>	
<p>1817B-BSA 1817B-BAL 1817B-BBR Black ESD Safe 1917B-BSA 1917B-BAL 1917B-BBR White DELRIN 500 • Curved Flat Tip</p>	<p>120 mm – 4 3/4"</p>	 <p>* 1.5 mm -.06"</p>	
<p>1818-BSA 1818-BAL 1818-BBR Black ESD Safe 1918-BSA 1918-BAL 1918-BBR White DELRIN 500 • For Handling and Positioning Quad Packs and Flat Parts</p>	<p>120 mm – 4 3/4"</p>	 <p>groove Ø1 mm -.04"</p>	
<p>1824-BSA 1824-BAL 1824-BBR Black ESD Safe 1924-BSA 1924-BAL 1924-BBR White DELRIN 500 • Very Fine Angulated Flat Tip</p>	<p>120 mm – 4 3/4"</p>	 <p>* 0.5 mm -.019"</p>	

RIVETED Soft Tip Tweezers, Black ESD Safe, STD Grey Static Dissipative, White DELRIN 500

With Stainless Antiacid Antimagnetic Handle Only



Made in Switzerland
Patented



- 300-SA series with Black ESD Safe Tip
- 300-SA-STD series with Grey Static Dissipative Tip
- 400-SA series with White DELRIN 500 Tip
- Available in Reverse Action, add prefix "R" (example R302-SA)
- Available with Patented EZ Lever, add suffix "-EZ" (example 302-SA-EZ)
- Available with Inside Serrated Tip, add suffix "D" (example 302D-SA)

<p>302-SA Black ESD Safe</p> <p>302-SA-STD Grey Static Dissipative</p> <p>402-SA White DELRIN 500</p> <ul style="list-style-type: none"> • Medium Tip 	<p>120 mm - 4 3/4"</p> <p>120 mm - 4 3/4"</p> <p>120 mm - 4 3/4"</p>	<p>* 2 mm - .08"</p>	
<p>303-SA Black ESD Safe</p> <p>303-SA-STD Grey Static Dissipative</p> <p>403-SA White DELRIN 500</p> <ul style="list-style-type: none"> • Strong Flat Tip 	<p>115 mm - 4 1/2"</p> <p>115 mm - 4 1/2"</p> <p>115 mm - 4 1/2"</p>	<p>* 2.3 mm - .09"</p>	
<p>304-SA Black ESD Safe</p> <p>304-SA-STD Grey Static Dissipative</p> <p>404-SA White DELRIN 500</p> <ul style="list-style-type: none"> • Fine Tip 	<p>120 mm - 4 3/4"</p> <p>120 mm - 4 3/4"</p> <p>120 mm - 4 3/4"</p>	<p>* 0.6 mm - .023"</p>	
<p>304B-SA Black ESD Safe</p> <p>304B-SA-STD Grey Static Dissipative</p> <p>404B-SA White DELRIN 500</p> <ul style="list-style-type: none"> • Curved Fine Tip 	<p>120 mm - 4 3/4"</p> <p>120 mm - 4 3/4"</p> <p>120 mm - 4 3/4"</p>	<p>* 0.6 mm - .023"</p>	
<p>304C-SA Black ESD Safe</p> <p>304C-SA-STD Grey Static Dissipative</p> <p>404C-SA White DELRIN 500</p> <ul style="list-style-type: none"> • Fine Tip 	<p>110 mm - 4 1/3"</p> <p>110 mm - 4 1/3"</p> <p>110 mm - 4 1/3"</p>	<p>* 0.6 mm - .023"</p>	

RIVETED Soft Tip Tweezers, Black ESD Safe, STD Grey Static Dissipative, White DELRIN 500



Made in Switzerland
Patented

With Stainless Antiacid Antimagnetic Handle Only

- Available in Reverse Action, add prefix "R" (example R309-SA)
- Available with Patented EZ Lever, add suffix "-EZ" (example 309-SA-EZ)
- Available with Inside Serrated Tip, add suffix "D" (example 309D-SA)

<p>306-SA Black ESD Safe 306-SA-STD Grey Static Dissipative 406-SA White DELRIN 500 • Strong Angulated SMD Flat Tip</p>	<p>120 mm - 4 3/4" 120 mm - 4 3/4" 120 mm - 4 3/4"</p>	<p>* 2.5 mm - .1"</p>	
<p>309-SA Black ESD Safe 309-SA-STD Grey Static Dissipative 409-SA White DELRIN 500 • Fine Angulated SMD Flat Tip</p>	<p>115 mm - 4 1/2" 115 mm - 4 1/2" 115 mm - 4 1/2"</p>	<p>* 1.5 mm - .06"</p>	
<p>310A-SA Black ESD Safe 310A-SA-STD Grey Static Dissipative 410A-SA White DELRIN 500 • Very Small Fine Angulated SMD Flat Tip</p>	<p>115 mm - 4 1/2" 115 mm - 4 1/2" 115 mm - 4 1/2"</p>	<p>* 0.6 mm - .023"</p>	
<p>315-SA Black ESD Safe 315-SA-STD Grey Static Dissipative 415-SA White DELRIN 500 • Extra Fine Tip</p>	<p>120 mm - 4 3/4" 120 mm - 4 3/4" 120 mm - 4 3/4"</p>	<p>* 0.3 mm - .011"</p>	
<p>316-SA Black ESD Safe 316-SA-STD Grey Static Dissipative 416-SA White DELRIN 500 • Very Fine Tip</p>	<p>120 mm - 4 3/4" 120 mm - 4 3/4" 120 mm - 4 3/4"</p>	<p>* 0.5 mm - .019"</p>	
<p>317-SA Black ESD Safe 317-SA-STD Grey Static Dissipative 417-SA White DELRIN 500 • Flat Tip</p>	<p>120 mm - 4 3/4" 120 mm - 4 3/4" 120 mm - 4 3/4"</p>	<p>* 1.5 mm - .06"</p>	
<p>317B-SA Black ESD Safe 317B-SA-STD Grey Static Dissipative 417B-SA White DELRIN 500 • Curved Flat Tip</p>	<p>120 mm - 4 3/4" 120 mm - 4 3/4" 120 mm - 4 3/4"</p>	<p>* 1.5 mm - .06"</p>	
<p>318-SA Black ESD Safe 318-SA-STD Grey Static Dissipative 418-SA White DELRIN 500 • For Handling and Positioning Quad Packs and Flat Parts</p>	<p>120 mm - 4 3/4" 120 mm - 4 3/4" 120 mm - 4 3/4"</p>	<p>groove Ø 1 mm - .04"</p>	

RIVETED Soft Tip Tweezers, Black ESD Safe, STD Grey Static Dissipative, White DELRIN 500



Made in Switzerland
Patented

With Stainless Antiacid Antimagnetic Handle Only

- Available in Reverse Action, add prefix "R" (example R324-SA)
- Available with Patented EZ Lever, add suffix "-EZ" (example 324-SA-EZ)
- Available with Inside Serrated Tip, add suffix "D" (example 324D-SA)

<p>318H-SA 120 mm - 4 3/4" Black ESD Safe 318H-SA-STD 120 mm - 4 3/4" Grey Static Dissipative 418H-SA 120 mm - 4 3/4" White DELRIN 500 • Perpendicular Groove Radius \varnothing 1.7 mm -.066" for Handlig Lenses and Flat Round Parts</p>		
<p>318V-SA 120 mm - 4 3/4" Black ESD Safe 318V-SA-STD 120 mm - 4 3/4" Grey Static Dissipative 418V-SA 120 mm - 4 3/4" White DELRIN 500 • For Handling Screws and Small Round Parts</p>		
<p>319H-SA 120 mm - 4 3/4" Black ESD Safe 319H-SA-STD 120 mm - 4 3/4" Grey Static Dissipative 419H-SA 120 mm - 4 3/4" White DELRIN 500 • Horizontal Groove, for Handling Lenses and Flat Round Parts</p>		
<p>320-SA / 320A-SA (45°) 120 mm - 4 3/4" Black ESD Safe 320-SA-STD / 320A-SA-STD (45°) 120 mm - 4 3/4" Grey Static Dissipative 420-SA / 420A-SA (45°) 120 mm - 4 3/4" White DELRIN 500 • For Handling Components, \varnothing 1.5 mm -.06" Hole</p>		
<p>322-SA / 322A-SA (45°) 120mm - 4 3/4" Black ESD Safe 322-SA-STD / 322A-SA-STD (45°) 120mm - 4 3/4" Grey Static Dissipative 422-SA / 422A-SA (45°) 120mm - 4 3/4" White DELRIN 500 • For Handling Components, \varnothing 2.5 mm -.1" Hole</p>		
<p>323C-SA 110 mm - 4 1/3" Black ESD Safe 323C-SA-STD 110 mm - 4 1/3" Grey Static Dissipative 423C-SA 110 mm - 4 1/3" White DELRIN 500 • With Unique Hole Positioning, Grasping a Ball Bearing of Almost any Size, From any Angle</p>		
<p>324-SA 120 mm - 4 3/4" Black ESD Safe 324-SA-STD 120 mm - 4 3/4" Grey Static Dissipative 424-SA 120 mm - 4 3/4" White DELRIN 500 • Very Fine Angulated Flat Tip</p>	<p>* 0.5 mm - .019"</p>	
<p>R330A-SA 150 mm - 6" Black ESD Safe R330A-SA-STD 150 mm - 6" Grey Static Dissipative R430A-SA 150 mm - 6" White DELRIN 500 • Reverse Action Only. For Handling and Positioning Large Quad Packs and Flat Parts</p>	<p>groove \varnothing 1 mm - .04" opening from 15 mm - .6" up to 45 mm - 1 3/4"</p>	

RIVETED Soft Tip Tweezers, Black ESD Safe, STD Grey Static Dissipative, White DELRIN 500



Made in Switzerland
Patented

With Stainless Antiacid Antimagnetic Handle Only

- Available in Reverse Action, add prefix "R" (example R352-SA)
- Available with Patented EZ Lever, add suffix "-EZ" (example 352-SA-EZ)
- Available with Inside Serrated Tip, add suffix "D" (example 352D-SA)

<p>350-SA Black ESD Safe 350-SA-STD Grey Static Dissipative 450-SA White DELRIN 500 • Wafer and Round Part Handling Tweezer</p>	<p>115 mm - 4 1/2" 115 mm - 4 1/2" 115 mm - 4 1/2"</p>	<p>* 10 mm - .4"</p>	
<p>351-SA Black ESD Safe 351-SA-STD Grey Static Dissipative 451-SA White DELRIN 500 • For Handling Components, Ø 1mm -.04" Hole</p>	<p>115 mm - 4 1/2" 115 mm - 4 1/2" 115 mm - 4 1/2"</p>		
<p>352-SA Black ESD Safe 352-SA-STD Grey Static Dissipative 452-SA White DELRIN 500 • Strong Angulated Flat Tip</p>	<p>115 mm - 4 1/2" 115 mm - 4 1/2" 115 mm - 4 1/2"</p>	<p>* 2.5 mm - .1"</p>	
<p>353-SA Black ESD Safe 353-SA-STD Grey Static Dissipative 453-SA White DELRIN 500 • Medium Angulated Fine Tip</p>	<p>115 mm - 4 1/2" 115 mm - 4 1/2" 115 mm - 4 1/2"</p>	<p>* 1 mm - .04"</p>	
<p>354-SA Black ESD Safe 354-SA-STD Grey Static Dissipative 454-SA White DELRIN 500 • Medium Curved Fine Tip</p>	<p>115 mm - 4 1/2" 115 mm - 4 1/2" 115 mm - 4 1/2"</p>	<p>* 1 mm - .04"</p>	
<p>355-SA Black ESD Safe 355-SA-STD Grey Static Dissipative 455-SA White DELRIN 500 • Strong Curved Tip</p>	<p>115 mm - 4 1/2" 115 mm - 4 1/2" 115 mm - 4 1/2"</p>	<p>* 2 mm - .08"</p>	
<p>356-SA Black ESD Safe 356-SA-STD Grey Static Dissipative 456-SA White DELRIN 500 • Straight Strong Flat Tip</p>	<p>115 mm - 4 1/2" 115 mm - 4 1/2" 115 mm - 4 1/2"</p>	<p>* 2 mm - .08"</p>	
<p>357-SA Black ESD Safe 357-SA-STD Grey Static Dissipative 457-SA White DELRIN 500 • Fine Straight Flat Tip</p>	<p>115 mm - 4 1/2" 115 mm - 4 1/2" 115 mm - 4 1/2"</p>	<p>* 1 mm - .04"</p>	

RIVETED RED SOFT TIP TWEEZERS

With Stainless Antiacid Antimagnetic Handle Only

- Available with Patented EZ Lever, add suffix "-EZ" (example 300-SA-EZ)



Made in
Switzerland
Patented



- Red Soft Antistatic Antimagnetic Tip
- Perfect for Handling SMD Parts, Ceramic Devices, Wafers, Delicate Parts
- Soft RED Synthetic Fiber

<p>300-SA Red Soft Fiber • Medium Tip</p>	<p>130 mm – 5 1/8"</p>	<p>* 2 mm -.08"</p>	
<p>300F-SA Red Soft Fiber • Flat Tip</p>	<p>130 mm – 5 1/8"</p>	<p>* 2.3 mm -.09"</p>	
<p>300AF-SA Red Soft Fiber • Strong 45° Flat Tip</p>	<p>130 mm – 5 1/8"</p>	<p>* 2.5 mm -.1"</p>	











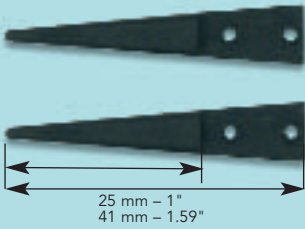

BLACK ESD SAFE Tips for QUICK CHANGE TWEEZERS

All Tips are also Available in:

- STD Grey Static Dissipative **TIP-STD**
- White DELRIN 500 **TIP-DEL**



Made in Switzerland
Patented

<p>TIP-ESD-2</p>  <p>25 mm – 1" 41 mm – 1.59"</p>	<p>TIP-ESD-3</p> 	<p>TIP-ESD-4</p> 
<p>TIP-ESD-4B</p> 	<p>TIP-ESD-6</p> 	<p>TIP-ESD-9</p> 
<p>TIP-ESD-10A</p> 	<p>TIP-ESD-15</p> 	<p>TIP-ESD-16</p> 
<p>TIP-ESD-17</p> 	<p>TIP-ESD-17B</p> 	<p>TIP-ESD-18</p> 
<p>TIP-ESD-24</p> 	<p>TIP-ESD-... Black ESD Safe fit on all HANDLES</p> <p>1300-SA / -AL / -BR / -BSA / -BAL / -BBR 1600-SA / -AL / -BR / -BSA / -BAL / -BBR 1800-SA / -AL / -BR / -BSA / -BAL / -BBR 1300C-SA, R1300-SA, R1300C-SA See pages 77-79</p>	

To Order Replacement Pair of TIP, Take the Last Digit(s) of the Tweezers Part Number and add it to TIP-ESD

Example : For Tweezers 130**2**-SA, or 160**2**-AL, or 180**2**-BR, etc., order Replacement Tip **TIP-ESD-2**
 For Tweezers 130**4B**-SA, or 160**4B**-AL, or 180**4B**-BR, etc., order Replacement Tip **TIP-ESD-4B**

OTHER MODELS AND CUSTOMIZED TIPS AVAILABLE UPON REQUEST

BLACK ESD SAFE Tips for QUICK CHANGE TWEEZERS

All Tips are also Available in:

- STD Grey Static Dissipative **TIP-STD**
- White DELRIN 500 **TIP-DEL**



Made in Switzerland
Patented

<p>TIP-ESD-18H</p>	<p>TIP-ESD-18V</p>	<p>TIP-ESD-19H</p>
<p>TIP-ESD-20</p>	<p>TIP-ESD-22</p>	<p>TIP-ESD-23C</p>
<p>TIP-ESD-30A</p>	<p>TIP-ESD-50</p>	<p>TIP-ESD-51</p>
<p>TIP-ESD-52</p>	<p>TIP-ESD-53</p>	<p>TIP-ESD-54</p>
<p>TIP-ESD-55</p>	<p>TIP-ESD-56</p>	<p>TIP-ESD-57</p>

TIP-ESD-... Black ESD Safe fit on all HANDLES

- 1300-SA / -AL / -BR / -BSA / -BAL / -BBR**
- 1600-SA / -AL / -BR / -BSA / -BAL / -BBR**
- 1800-SA / -AL / -BR / -BSA / -BAL / -BBR**
- 1300C-SA, R1300-SA, R1300C-SA**

To Order Replacement Pair of TIP, Take the Last Digit(s) of the Tweezers Part Number and add it to TIP-ESD
 Example : For Tweezers 13**18H**-SA, or 16**18H**-AL, or 18**18H**-BR, etc., order Replacement Tip **TIP-ESD-18H**
 For Tweezers 13**50**-SA, or 16**50**-AL, or 18**50**-BR, etc., order Replacement Tip **TIP-ESD-50**

OTHER MODELS AND CUSTOMIZED TIPS AVAILABLE UPON REQUEST

WHITE DELRIN 500 Tips for QUICK CHANGE TWEEZERS

All Tips are also Available in:

- Black ESD Safe **TIP-ESD**
- STD Grey Static Dissipative **TIP-STD**



Made in Switzerland
Patented

<p>TIP-DEL-2</p> <p>25 mm - 1" 41 mm - 1.59"</p>	<p>TIP-DEL-3</p>	<p>TIP-DEL-4</p>
<p>TIP-DEL-4B</p>	<p>TIP-DEL-6</p>	<p>TIP-DEL-9</p>
<p>TIP-DEL-10A</p>	<p>TIP-DEL-15</p>	<p>TIP-DEL-16</p>
<p>TIP-DEL-17</p>	<p>TIP-DEL-17B</p>	<p>TIP-DEL-18</p>
<p>TIP-DEL-24</p>	<p>TIP-DEL-... White DELRIN 500 fit on all HANDLES 1300-SA / -AL / -BR / -BSA / -BAL / -BBR 1600-SA / -AL / -BR / -BSA / -BAL / -BBR 1800-SA / -AL / -BR / -BSA / -BAL / -BBR 1300C-SA, R1300-SA, R1300C-SA See pages 77-79</p>	

To Order Replacement Pair of TIP, Take the Last Digit(s) of the Tweezers Part Number and add it to TIP-DEL

Example : For Tweezers 140**2**-SA, or 170**2**-AL, or 190**2**-BR, etc., order Replacement Tip **TIP-DEL-2**
 For Tweezers 140**4B**-SA, or 170**4B**-AL, or 190**4B**-BR, etc., order Replacement Tip **TIP-DEL-4B**

OTHER MODELS AND CUSTOMIZED TIPS AVAILABLE UPON REQUEST















WHITE DELRIN 500 Tips for QUICK CHANGE TWEEZERS

All Tips are also Available in:

- Black ESD Safe **TIP-ESD**
- STD Grey Static Dissipative **TIP-STD**



Made in Switzerland
Patented

<p>TIP-DEL-18H</p> 	<p>TIP-DEL-18V</p> 	<p>TIP-DEL-19H</p> 
<p>TIP-DEL-20</p> 	<p>TIP-DEL-22</p> 	<p>TIP-DEL-23C</p> 
<p>TIP-DEL-30A</p> 	<p>TIP-DEL-50</p> 	<p>TIP-DEL-51</p> 
<p>TIP-DEL-52</p> 	<p>TIP-DEL-53</p> 	<p>TIP-DEL-54</p> 
<p>TIP-DEL-55</p> 	<p>TIP-DEL-56</p> 	<p>TIP-DEL-57</p> 

TIP-DEL-... White DELRIN 500 fit on all HANDLES

1300-SA / -AL / -BR / -BSA / -BAL / -BBR
1600-SA / -AL / -BR / -BSA / -BAL / -BBR
1800-SA / -AL / -BR / -BSA / -BAL / -BBR
1300C-SA, R1300-SA, R1300C-SA

To Order Replacement Pair of TIP, Take the Last Digit(s) of the Tweezers Part Number and add it to TIP-DEL
 Example : For Tweezers 14**18H**-SA, or 17**18H**-AL, or 19**18H**-BR, etc., order Replacement Tip **TIP-DEL-18H**
 For Tweezers 14**50**-SA, or 17**50**-AL, or 19**50**-BR, etc., order Replacement Tip **TIP-DEL-50**

OTHER MODELS AND CUSTOMIZED TIPS AVAILABLE UPON REQUEST

STD GREY Static Dissipative Tips for QUICK CHANGE Lead Straightener and Wafer Handling Tweezers



Made in Switzerland
Patented

All Tips are also Available in: - Black ESD Safe **TIP-ESD**
- White DELRIN 500 **TIP-DEL**

<p>TIP-STD-2</p> <p>25 mm - 1" 41 mm - 1.59"</p>	<p>TIP-STD-3</p>	<p>TIP-STD-4</p>
<p>TIP-STD-4B</p>	<p>TIP-STD-15</p>	<p>TIP-STD-16</p>
<p>TIP-STD-17</p>	<p>TIP-STD-17B</p>	

Other STD Tips available:

TIP-STD-6	TIP-STD-9	TIP-STD-10A	TIP-STD-18	TIP-STD-18H	TIP-STD-18V	TIP-STD-19H
TIP-STD-20	TIP-STD-22	TIP-STD-23C	TIP-STD-24	TIP-STD-30A	TIP-STD-50	TIP-STD-51
TIP-STD-52	TIP-STD-53	TIP-STD-54	TIP-STD-55	TIP-STD-56	TIP-STD-57	

See Pages 44 to 47

<p>TIP-T5508W-STD</p>	<p>TIP-T5509W-STD</p>	<p>Other models available:</p> <p>TIP-T5508-STD TIP-T5531-STD TIP-1390W-STD TIP-T5510W-STD</p> <p>See pages 49 to 50</p>
------------------------------	------------------------------	--

TIP-STD... Grey Static Dissipative fit on all HANDLES

1300-SA / -AL / -BR / -BSA / -BAL / -BBR
1600-SA / -AL / -BR / -BSA / -BAL / -BBR
1800-SA / -AL / -BR / -BSA / -BAL / -BBR
1300C-SA, R1300-SA, R1300C-SA

See pages 77-79

To Order Replacement Pair of TIP, Take the Last Digit(s) of the Tweezers Part Number and add it to TIP-STD

Example : For Tweezers 130**2**-SA-STD, or 160**2**-AL-STD, or 180**2**-BR-STD, etc., order Replacement Tip **TIP-STD-2**
For Tweezers 130**4B**-SA-STD, or 160**4B**-AL-STD, or 180**4B**-BR-STD, etc., order Replacement Tip **TIP-STD-4B**

OTHER MODELS AND CUSTOMIZED TIPS AVAILABLE UPON REQUEST

BLACK ESD SAFE Tips for QUICK CHANGE

Lead Straightener and Wafer Handling Tweezers - See page 28

All Tips are also Available in: - STD Grey Static Dissipative **TIP-STD**
- White DELRIN 500 **TIP-DEL**



Made in Switzerland
Patented

Lead Straightener
TIP-T5508

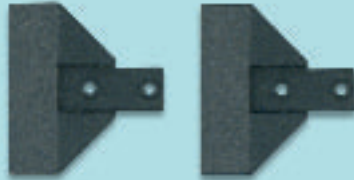

Lead Straightener
TIP-T5531



Wafer Handling Tweezers
TIP-1390W



Wafer Handling Tweezers
TIP-T5508W



Wafer Handling Tweezers
TIP-T5509W

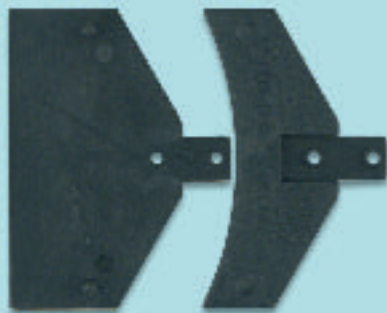

Wafer Handling Tweezers
TIP-T5510W

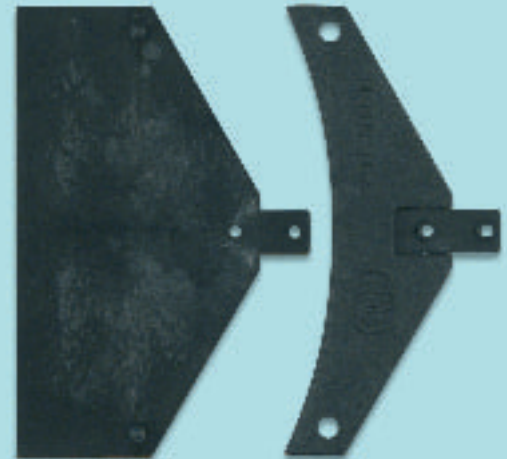

All Tips Above Fit on HANDLES

T5000-SA / RT5000-SA
TS5000-SA / RTS5000-SA
1300-SA-EZ / R1300-SA-EZ

See page 78

To order, add Prefix **TIP** to the Tweezers Part Number

Example : For Wafer Handling Tweezers T5508W-SA Replacement Tips, order **TIP-T5508W**

OTHER MODELS AND CUSTOMIZED TIPS AVAILABLE UPON REQUEST

WHITE DELRIN 500 Tips for QUICK CHANGE

Lead Straightener and Wafer Handling Tweezers - See page 28

All Tips are also Available in: - Black ESD Safe **TIP-ESD**
 - STD Grey Static Dissipative **TIP-STD**



Made in
Switzerland
Patented

**Lead Straightener
TIP-T5608**



**Lead Straightener
TIP-T5631**



**Wafer Handling Tweezers
TIP-1490W**



**Wafer Handling Tweezers
TIP-T5608W**



**Wafer Handling Tweezers
TIP-T5609W**



**Wafer Handling Tweezers
TIP-T5610W**



All Tips Above Fit on HANDLES **T5000-SA / RT5000-SA**
 TS5000-SA / RTS5000-SA
 1300-SA-EZ / R1300-SA-EZ

See page 78

To order, add Prefix **TIP** to the Tweezers Part Number
Example : For Wafer Handling Tweezers T5608W-SA Replacement Tips, order **TIP-T5608W**

OTHER MODELS AND CUSTOMIZED TIPS AVAILABLE UPON REQUEST

CERAMIC QUICK CHANGE TWEEZERS



Made in
Switzerland
Patented



CERAMIC QUICK CHANGE TWEEZERS CW1300 series



Made in Switzerland
Patented

With White Antistatic Ceramic Tip

- Stainless Antiacid Antimagnetic Handle, add suffix "-SA"
- Aluminum Handle, add suffix "-AL"
- Brass Handle, add suffix "-BR"

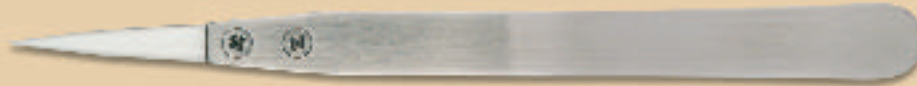

CW1304-SA



CW1304-AL



CW1304-BR

Part Number Length CW1302-SA

CW1302C-SA	110 mm	4 1/3"
CW1302-SA	120 mm	4 3/4"
CW1302-AL	120 mm	4 3/4"
CW1302-BR	120 mm	4 3/4"

- Medium Tip

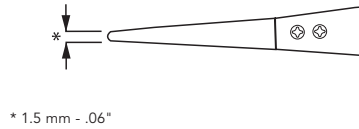

* 1.5 mm - .06"



Part Number Length CW1303-SA

CW1303C-SA	105 mm	4 1/6"
CW1303-SA	115 mm	4 1/2"
CW1303-AL	115 mm	4 1/2"
CW1303-BR	115 mm	4 1/2"

- Strong Flat Tip

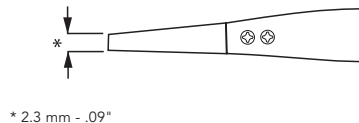

* 2.3 mm - .09"



Part Number Length CW1304-SA

CW1304C-SA	110 mm	4 1/3"
CW1304-SA	120 mm	4 3/4"
CW1304-AL	120 mm	4 3/4"
CW1304-BR	120 mm	4 3/4"

- Fine Tip

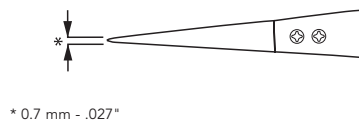

* 0.7 mm - .027"



Available in Reverse Action, add prefix "R" (example RCW1302-SA)

CERAMIC QUICK CHANGE TWEEZERS CW1300 series



Made in Switzerland
Patented

With White Antistatic Ceramic Tip

- Stainless Antiacid Antimagnetic Handle, add suffix "-SA"
- Aluminum Handle, add suffix "-AL"
- Brass Handle, add suffix "-BR"

Part Number	Length		CW1309-SA	
CW1309C-SA	105 mm	4 1/6"	<p>* 1.5 mm - .06"</p>	
CW1309-SA	115 mm	4 1/2"		
CW1309-AL	115 mm	4 1/2"		
CW1309-BR	115 mm	4 1/2"		
<ul style="list-style-type: none"> • Fine Angulated SMD Flat Tip 				

Part Number	Length		CW1310A-SA	
CW1310AC-SA	105 mm	4 1/6"	<p>* 0.6 mm - .023"</p>	
CW1310A-SA	115 mm	4 1/2"		
CW1310A-AL	115 mm	4 1/2"		
CW1310A-BR	115 mm	4 1/2"		
<ul style="list-style-type: none"> • Very Small Fine Angulated SMD Flat Tip 				

Part Number	Length		CW1315-SA	
CW1315C-SA	110 mm	4 1/3"	<p>* 0.3 mm - .011"</p>	
CW1315-SA	120 mm	4 3/4"		
CW1315-AL	120 mm	4 3/4"		
CW1315-BR	120 mm	4 3/4"		
<ul style="list-style-type: none"> • Extra Fine Tip 				

Part Number	Length		CW1316-SA	
CW1316C-SA	110 mm	4 1/3"	<p>* 0.4 mm - .015"</p>	
CW1316-SA	120 mm	4 3/4"		
CW1316-AL	120 mm	4 3/4"		
CW1316-BR	120 mm	4 3/4"		
<ul style="list-style-type: none"> • Very Fine Tip 				

Part Number	Length		CW1317-SA	
CW1317C-SA	110 mm	4 1/3"	<p>* 1.5 mm - .06"</p>	
CW1317-SA	120 mm	4 3/4"		
CW1317-AL	120 mm	4 3/4"		
CW1317-BR	120 mm	4 3/4"		
<ul style="list-style-type: none"> • Flat Tip 				

Available in Reverse Action, add prefix "R" (example RCW1302-SA)

CERAMIC QUICK CHANGE TWEEZERS CW1600 series



Made in Switzerland
Patented

With White Antistatic Ceramic Tip

- Stainless Antiacid Antimagnetic Serrated Handle, add suffix "-SA"
- Aluminum Serrated Handle, add suffix "-AL"
- Brass Serrated Handle, add suffix "-BR"



CW1604-SA



CW1604-AL



CW1604-BR

Part Number Length CW1602-SA

CW1602-SA	120 mm	4 3/4"
CW1602-AL	120 mm	4 3/4"
CW1602-BR	120 mm	4 3/4"

- Medium Tip

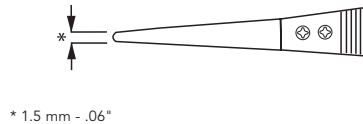

* 1.5 mm - .06"



Part Number Length CW1603-SA

CW1603-SA	115 mm	4 1/2"
CW1603-AL	115 mm	4 1/2"
CW1603-BR	115 mm	4 1/2"

- Strong Flat Tip

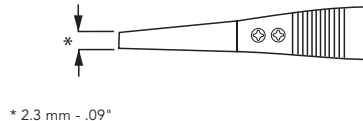

* 2.3 mm - .09"



Part Number Length CW1604-SA

CW1604-SA	120 mm	4 3/4"
CW1604-AL	120 mm	4 3/4"
CW1604-BR	120 mm	4 3/4"

- Fine Tip

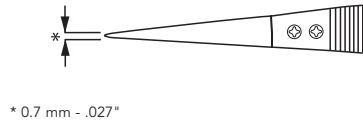

* 0.7 mm - .027"



CERAMIC QUICK CHANGE TWEEZERS CW1600 series



Made in Switzerland
Patented

With White Antistatic Ceramic Tip

- Stainless Antiacid Antimagnetic Serrated Handle, add suffix "-SA"
- Aluminum Serrated Handle, add suffix "-AL"
- Brass Serrated Handle, add suffix "-BR"

Part Number	Length		CW1609-SA	
CW1609-SA	115 mm	4 1/2"	<p>* 1.5 mm - .06"</p>	
CW1609-AL	115 mm	4 1/2"		
CW1609-BR	115 mm	4 1/2"		
• Fine Angulated SMD Flat Tip				
Part Number	Length		CW1610A-SA	
CW1610A-SA	115 mm	4 1/2"	<p>* 0.6 mm - .023"</p>	
CW1610A-AL	115 mm	4 1/2"		
CW1610A-BR	115 mm	4 1/2"		
• Very Small Fine Angulated SMD Flat Tip				
Part Number	Length		CW1615-SA	
CW1615-SA	120 mm	4 3/4"	<p>* 0.3 mm - .011"</p>	
CW1615-AL	120 mm	4 3/4"		
CW1615-BR	120 mm	4 3/4"		
• Extra Fine Tip				
Part Number	Length		CW1616-SA	
CW1616-SA	120 mm	4 3/4"	<p>* 0.4 mm - .015"</p>	
CW1616-AL	120 mm	4 3/4"		
CW1616-BR	120 mm	4 3/4"		
• Very Fine Tip				
Part Number	Length		CW1617-SA	
CW1617-SA	120 mm	4 3/4"	<p>* 1.5 mm - .06"</p>	
CW1617-AL	120 mm	4 3/4"		
CW1617-BR	120 mm	4 3/4"		
• Flat Tip				

CERAMIC QUICK CHANGE TWEEZERS CW1800 series



Made in Switzerland
Patented

With White Antistatic Ceramic Tip

- Stainless Antiacid Antimagnetic Handle, add suffix "-SA"
- Aluminum Handle, add suffix "-AL"
- Brass Handle, add suffix "-BR"



CW1804-SA



CW1804-AL



CW1804-BR

Part Number Length CW1802-SA

CW1802-SA	135 mm	5 1/4"
CW1802-AL	135 mm	5 1/4"
CW1802-BR	135 mm	5 1/4"

- Medium Tip

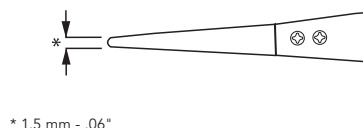

* 1.5 mm - .06"



Part Number Length CW1803-SA

CW1803-SA	127 mm	5"
CW1803-AL	127 mm	5"
CW1803-BR	127 mm	5"

- Strong Flat Tip

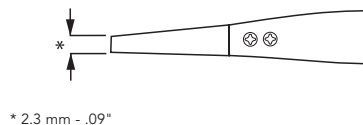

* 2.3 mm - .09"



Part Number Length CW1804-SA

CW1804-SA	135 mm	5 1/4"
CW1804-AL	135 mm	5 1/4"
CW1804-BR	135 mm	5 1/4"

- Fine Tip

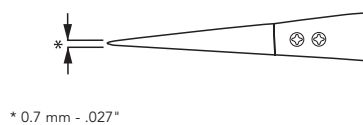

* 0.7 mm - .027"



CERAMIC QUICK CHANGE TWEEZERS CW1800 series



Made in Switzerland
Patented

With White Antistatic Ceramic Tip

- Stainless Antiacid Antimagnetic Handle, add suffix "-SA"
- Aluminum Handle, add suffix "-AL"
- Brass Handle, add suffix "-BR"

Part Number	Length		CW1809-SA	
CW1809-SA	127 mm	5"	<p>* 1.5 mm - .06"</p>	
CW1809-AL	127 mm	5"		
CW1809-BR	127 mm	5"		
<ul style="list-style-type: none"> • Fine Angulated SMD Flat Tip 				

Part Number	Length		CW1810A-SA	
CW1810A-SA	127 mm	5"	<p>* 0.6 mm - .023"</p>	
CW1810A-AL	127 mm	5"		
CW1810A-BR	127 mm	5"		
<ul style="list-style-type: none"> • Very Small Fine Angulated SMD Flat Tip 				

Part Number	Length		CW1815-SA	
CW1815-SA	135 mm	5 1/4"	<p>* 0.3 mm - .011"</p>	
CW1815-AL	135 mm	5 1/4"		
CW1815-BR	135 mm	5 1/4"		
<ul style="list-style-type: none"> • Extra Fine Tip 				

Part Number	Length		CW1816-SA	
CW1816-SA	135 mm	5 1/4"	<p>* 0.4 mm - .015"</p>	
CW1816-AL	135 mm	5 1/4"		
CW1816-BR	135 mm	5 1/4"		
<ul style="list-style-type: none"> • Very Fine Tip 				

Part Number	Length		CW1817-SA	
CW1817-SA	135 mm	5 1/4"	<p>* 1.5 mm - .06"</p>	
CW1817-AL	135 mm	5 1/4"		
CW1817-BR	135 mm	5 1/4"		
<ul style="list-style-type: none"> • Flat Tip 				

CERAMIC QUICK CHANGE TWEEZERS with 45° Bent Handle

CW1300-B series with White Antistatic Ceramic Tip

- Stainless Antiacid Antimagnetic Bent Handle, add suffix "-BSA"
- Aluminum Bent Handle, add suffix "-BAL"
- Brass Bent Handle, add suffix "-BBR"



Made in Switzerland
Patented



Part Number Length **CW1302-BSA**

CW1302-BSA	110 mm	4 1/3"
CW1302-BAL	110 mm	4 1/3"
CW1302-BBR	110 mm	4 1/3"

- Medium Tip

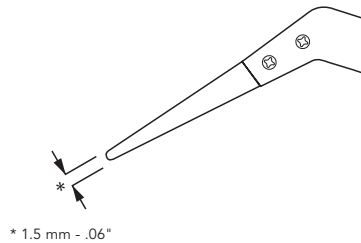

Part Number Length **CW1303-BSA**

CW1303-BSA	105 mm	4 1/6"
CW1303-BAL	105 mm	4 1/6"
CW1303-BBR	105 mm	4 1/6"

- Strong Flat Tip

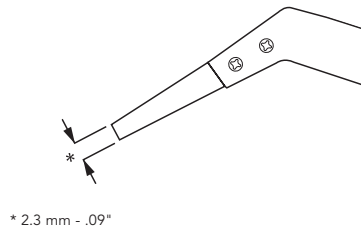

Part Number Length **CW1304-BSA**

CW1304-BSA	110 mm	4 1/3"
CW1304-BAL	110 mm	4 1/3"
CW1304-BBR	110 mm	4 1/3"

- Fine Tip

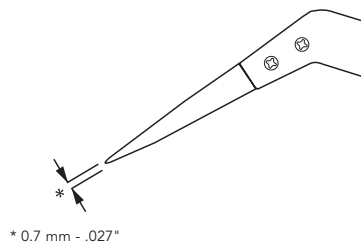









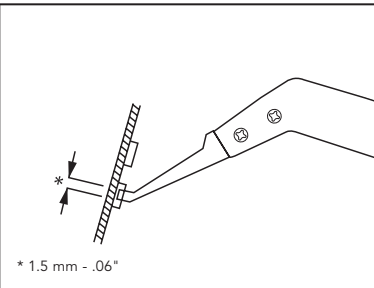

CERAMIC QUICK CHANGE TWEEZERS with 45° Bent Handle

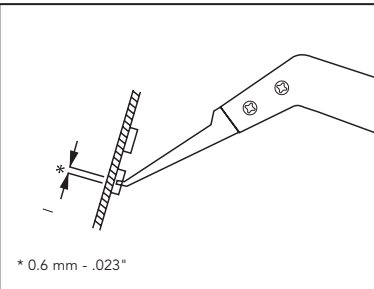
CW1300-B series with White Antistatic Ceramic Tip

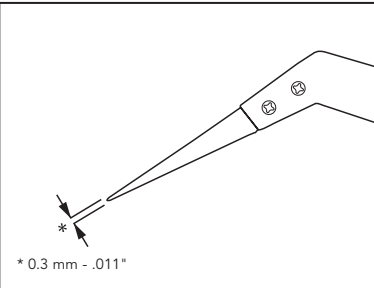
- Stainless Antiacid Antimagnetic Bent Handle, add suffix "-BSA"
- Aluminum Bent Handle, add suffix "-BAL"
- Brass Bent Handle, add suffix "-BBR"

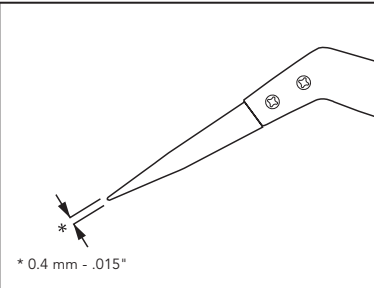

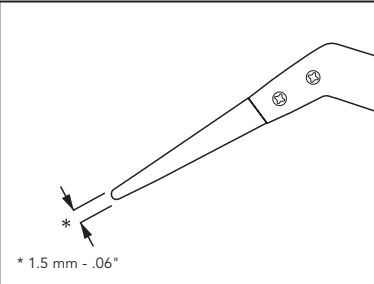
Made in Switzerland
Patented

Part Number	Length		CW1309-BSA	
CW1309-BSA	105 mm	4 1/6"	 <p>* 1.5 mm - .06"</p>	
CW1309-BAL	105 mm	4 1/6"		
CW1309-BBR	105 mm	4 1/6"		
• Fine Angulated SMD Flat Tip				
Part Number	Length		CW1310A-BSA	
CW1310A-BSA	105 mm	4 1/6"	 <p>* 0.6 mm - .023"</p>	
CW1310A-BAL	105 mm	4 1/6"		
CW1310A-BBR	105 mm	4 1/6"		
• Very Small Fine Angulated SMD Flat Tip				
Part Number	Length		CW1315-BSA	
CW1315-BSA	110 mm	4 1/3"	 <p>* 0.3 mm - .011"</p>	
CW1315-BAL	110 mm	4 1/3"		
CW1315-BBR	110 mm	4 1/3"		
• Extra Fine Tip				
Part Number	Length		CW1316-BSA	
CW1316-BSA	110 mm	4 1/3"	 <p>* 0.4 mm - .015"</p>	
CW1316-BAL	110 mm	4 1/3"		
CW1316-BBR	110 mm	4 1/3"		
• Very Fine Tip				
Part Number	Length		CW1317-BSA	
CW1317-BSA	110 mm	4 1/3"	 <p>* 1.5 mm - .06"</p>	
CW1317-BAL	110 mm	4 1/3"		
CW1317-BBR	110 mm	4 1/3"		
• Flat Tip				

CERAMIC QUICK CHANGE TWEEZERS with 45° Bent Handle

CW1600-B series with White Antistatic Ceramic Tip

- Stainless Antiacid Antimagnetic Serrated Bent Handle, add suffix "-BSA"
- Aluminum Serrated Bent Handle, add suffix "-BAL"
- Brass Serrated Bent Handle, add suffix "-BBR"



Made in Switzerland
Patented



Part Number Length **CW1602-BSA**

CW1602-BSA	110 mm	4 1/3"
CW1602-BAL	110 mm	4 1/3"
CW1602-BBR	110 mm	4 1/3"

- Medium Tip

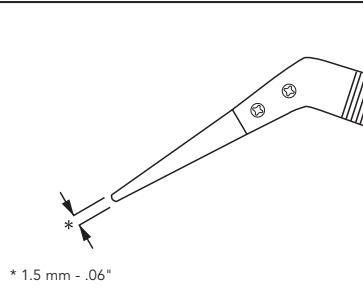

Part Number Length **CW1603-BSA**

CW1603-BSA	105 mm	4 1/6"
CW1603-BAL	105 mm	4 1/6"
CW1603-BBR	105 mm	4 1/6"

- Strong Flat Tip

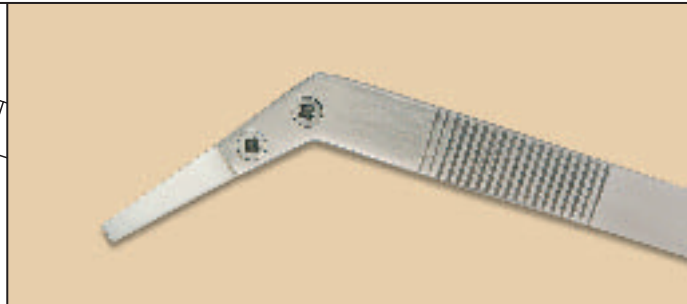
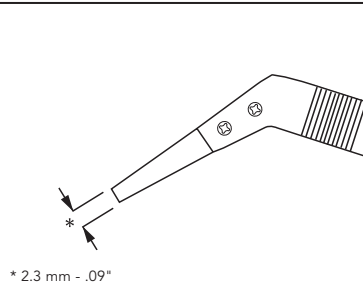

Part Number Length **CW1604-BSA**

CW1604-BSA	110 mm	4 1/3"
CW1604-BAL	110 mm	4 1/3"
CW1604-BBR	110 mm	4 1/3"

- Fine Tip

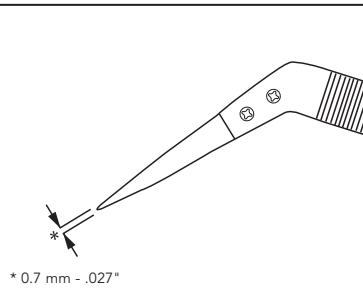









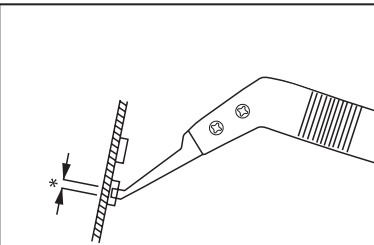

CERAMIC QUICK CHANGE TWEEZERS with 45° Bent Handle

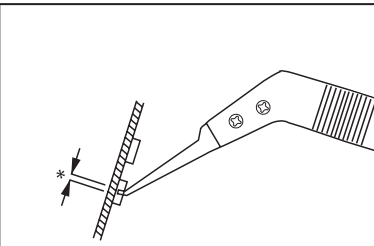
CW1600-B series with White Antistatic Ceramic Tip

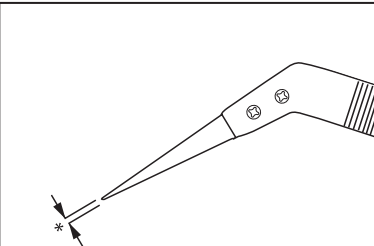
- Stainless Antiacid Antimagnetic Serrated Bent Handle, add suffix "-BSA"
- Aluminum Serrated Bent Handle, add suffix "-BAL"
- Brass Serrated Bent Handle, add suffix "-BBR"

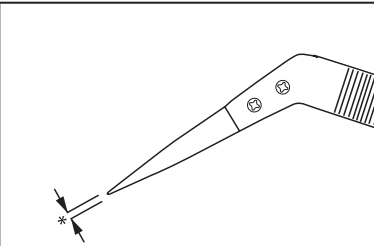

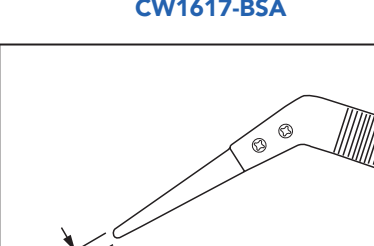
Made in Switzerland
Patented

Part Number	Length		CW1609-BSA
CW1609-BSA	105 mm	4 1/6"	 <p>* 1.5 mm - .06"</p>
CW1609-BAL	105 mm	4 1/6"	
CW1609-BBR	105 mm	4 1/6"	
• Fine Angulated SMD Flat Tip			
Part Number	Length		CW1610A-BSA
CW1610A-BSA	105 mm	4 1/6"	 <p>* 0.6 mm - .023"</p>
CW1610A-BAL	105 mm	4 1/6"	
CW1610A-BBR	105 mm	4 1/6"	
• Very Small Fine Angulated SMD Flat Tip			
Part Number	Length		CW1615-BSA
CW1615-BSA	110 mm	4 1/3"	 <p>* 0.3 mm - .011"</p>
CW1615-BAL	110 mm	4 1/3"	
CW1615-BBR	110 mm	4 1/3"	
• Extra Fine Tip			
Part Number	Length		CW1616-BSA
CW1616-BSA	110 mm	4 1/3"	 <p>* 0.4 mm - .015"</p>
CW1616-BAL	110 mm	4 1/3"	
CW1616-BBR	110 mm	4 1/3"	
• Very Fine Tip			
Part Number	Length		CW1617-BSA
CW1617-BSA	110 mm	4 1/3"	 <p>* 1.5 mm - .06"</p>
CW1617-BAL	110 mm	4 1/3"	
CW1617-BBR	110 mm	4 1/3"	
• Flat Tip			

CERAMIC QUICK CHANGE TWEEZERS with 45° Bent Handle

CW1800-B series with White Antistatic Ceramic Tip

- Stainless Antiacid Antimagnetic Bent Handle, add suffix "-BSA"
- Aluminum Bent Handle, add suffix "-BAL"
- Brass Bent Handle, add suffix "-BBR"



Made in Switzerland
Patented



Part Number Length **CW1802-BSA**

CW1802-BSA	120 mm	4 3/4"
CW1802-BAL	120 mm	4 3/4"
CW1802-BBR	120 mm	4 3/4"

- Medium Tip

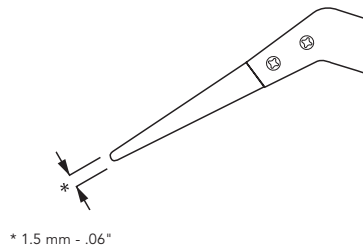

* 1.5 mm - .06"



Part Number Length **CW1803-BSA**

CW1803-BSA	115 mm	4 1/2"
CW1803-BAL	115 mm	4 1/2"
CW1803-BBR	115 mm	4 1/2"

- Strong Flat Tip

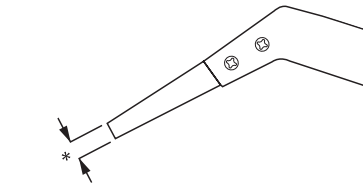

* 2.3 mm - .09"



Part Number Length **CW1804-BSA**

CW1804-BSA	120 mm	4 3/4"
CW1804-BAL	120 mm	4 3/4"
CW1804-BBR	120 mm	4 3/4"

- Fine Tip

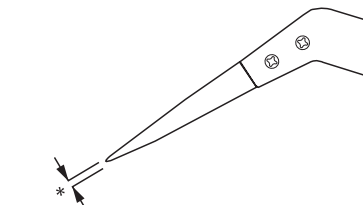

* 0.7 mm - .027"



CERAMIC QUICK CHANGE TWEEZERS with 45° Bent Handle

CW1800-B series with White Antistatic Ceramic Tip

- Stainless Antiacid Antimagnetic Bent Handle, add suffix "-BSA"
- Aluminum Bent Handle, add suffix "-BAL"
- Brass Bent Handle, add suffix "-BBR"



Made in Switzerland
Patented

Part Number	Length		CW1809-BSA	
CW1809-BSA	115 mm	4 1/2"	<p>* 1.5 mm - .06"</p>	
CW1809-BAL	115 mm	4 1/2"		
CW1809-BBR	115 mm	4 1/2"		
• Fine Angulated SMD Flat Tip				
Part Number	Length		CW1810A-BSA	
CW1810A-BSA	115 mm	4 1/2"	<p>* 0.6 mm - .023"</p>	
CW1810A-BAL	115 mm	4 1/2"		
CW1810A-BBR	115 mm	4 1/2"		
• Very Small Fine Angulated SMD Flat Tip				
Part Number	Length		CW1815-BSA	
CW1815-BSA	120 mm	4 3/4"	<p>* 0.3 mm - .011"</p>	
CW1815-BAL	120 mm	4 3/4"		
CW1815-BBR	120 mm	4 3/4"		
• Extra Fine Tip				
Part Number	Length		CW1816-BSA	
CW1816-BSA	120 mm	4 3/4"	<p>* 0.4 mm - .015"</p>	
CW1816-BAL	120 mm	4 3/4"		
CW1816-BBR	120 mm	4 3/4"		
• Very Fine Tip				
BPart Number	Length		CW1817-BSA	
CW1817-BSA	120 mm	4 3/4"	<p>* 1.5 mm - .06"</p>	
CW1817-BAL	120 mm	4 3/4"		
CW1817-BBR	120 mm	4 3/4"		
• Flat Tip				

CERAMIC QUICK CHANGE TWEEZERS CB1300 series



Made in Switzerland
Patented

With Black ESD Safe Ceramic Tip

- Stainless Antiacid Antimagnetic Handle, add suffix "-SA"
- Aluminum Handle, add suffix "-AL"
- Brass Handle, add suffix "-BR"



CB1304-SA



CB1304-AL



CB1304-BR

Part Number Length CB1302-SA

CB1302C-SA	110 mm	4 1/3"
CB1302-SA	120 mm	4 3/4"
CB1302-AL	120 mm	4 3/4"
CB1302-BR	120 mm	4 3/4"

- Medium Tip



* 1.5 mm - .06"



Part Number Length CB1303-SA

CB1303C-SA	105 mm	4 1/6"
CB1303-SA	115 mm	4 1/2"
CB1303-AL	115 mm	4 1/2"
CB1303-BR	115 mm	4 1/2"

- Strong Flat Tip

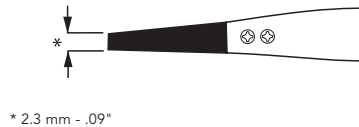

* 2.3 mm - .09"



Part Number Length CB1304-SA

CB1304C-SA	110 mm	4 1/3"
CB1304-SA	120 mm	4 3/4"
CB1304-AL	120 mm	4 3/4"
CB1304-BR	120 mm	4 3/4"

- Fine Tip



* 0.7 mm - .027"



Available in Reverse Action, add prefix "R" (example RCB1302-SA)

CERAMIC QUICK CHANGE TWEEZERS CB1300 series



Made in Switzerland
Patented

With Black ESD Safe Ceramic Tip

- Stainless Antiacid Antimagnetic Handle, add suffix "-SA"
- Aluminum Handle, add suffix "-AL"
- Brass Handle, add suffix "-BR"

Part Number	Length		CB1309-SA	
CB1309C-SA	105 mm	4 1/6"	<p>* 1.5 mm - .06"</p>	
CB1309-SA	115 mm	4 1/2"		
CB1309-AL	115 mm	4 1/2"		
CB1309-BR	115 mm	4 1/2"		
<ul style="list-style-type: none"> • Fine Angulated SMD Flat Tip 				

Part Number	Length		CB1310A-SA	
CB1310AC-SA	105 mm	4 1/6"	<p>* 0.6 mm - .023"</p>	
CB1310A-SA	115 mm	4 1/2"		
CB1310A-AL	115 mm	4 1/2"		
CB1310A-BR	115 mm	4 1/2"		
<ul style="list-style-type: none"> • Very Small Fine Angulated SMD Flat Tip 				

Part Number	Length		CB1315-SA	
CB1315C-SA	110 mm	4 1/3"	<p>* 0.3 mm - .011"</p>	
CB1315-SA	120 mm	4 3/4"		
CB1315-AL	120 mm	4 3/4"		
CB1315-BR	120 mm	4 3/4"		
<ul style="list-style-type: none"> • Extra Fine Tip 				

Part Number	Length		CB1316-SA	
CB1316C-SA	110 mm	4 1/3"	<p>* 0.4 mm - .015"</p>	
CB1316-SA	120 mm	4 3/4"		
CB1316-AL	120 mm	4 3/4"		
CB1316-BR	120 mm	4 3/4"		
<ul style="list-style-type: none"> • Very Fine Tip 				

Part Number	Length		CB1317-SA	
CB1317C-SA	110 mm	4 1/3"	<p>* 1.5 mm - .06"</p>	
CB1317-SA	120 mm	4 3/4"		
CB1317-AL	120 mm	4 3/4"		
CB1317-BR	120 mm	4 3/4"		
<ul style="list-style-type: none"> • Flat Tip 				

Available in Reverse Action, add prefix "R" (example RCB1302-SA)

CERAMIC QUICK CHANGE TWEEZERS CB1600 series

With Black ESD Safe Ceramic Tip

- Stainless Antiacid Antimagnetic Serrated Handle, add suffix "-SA"
- Aluminum Serrated Handle, add suffix "-AL"
- Brass Serrated Handle, add suffix "-BR"



Made in Switzerland
Patented

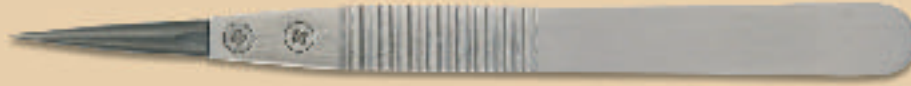

CB1604-SA



CB1604-AL



CB1604-BR

Part Number Length CB1602-SA

CB1602-SA	120 mm	4 3/4"
CB1602-AL	120 mm	4 3/4"
CB1602-BR	120 mm	4 3/4"

- Medium Tip



* 1.5 mm - .06"



Part Number Length CB1603-SA

CB1603-SA	115 mm	4 1/2"
CB1603-AL	115 mm	4 1/2"
CB1603-BR	115 mm	4 1/2"

- Strong Flat Tip



* 2.3 mm - .09"



Part Number Length CB1604-SA

CB1604-SA	120 mm	4 3/4"
CB1604-AL	120 mm	4 3/4"
CB1604-BR	120 mm	4 3/4"

- Fine Tip



* 0.7 mm - .027"



CERAMIC QUICK CHANGE TWEEZERS CB1600 series



Made in Switzerland
Patented

With Black ESD Safe Ceramic Tip

- Stainless Antiacid Antimagnetic Serrated Handle, add suffix "-SA"
- Aluminum Serrated Handle, add suffix "-AL"
- Brass Serrated Handle, add suffix "-BR"

Part Number	Length		CB1609-SA	
CB1609-SA	115 mm	4 1/2"	<p>* 1.5 mm - .06"</p>	
CB1609-AL	115 mm	4 1/2"		
CB1609-BR	115 mm	4 1/2"		
<ul style="list-style-type: none"> • Fine Angulated SMD Flat Tip 				

Part Number	Length		CB1610A-SA	
CB1610A-SA	115 mm	4 1/2"	<p>* 0.6 mm - .023"</p>	
CB1610A-AL	115 mm	4 1/2"		
CB1610A-BR	115 mm	4 1/2"		
<ul style="list-style-type: none"> • Very Small Fine Angulated SMD Flat Tip 				

Part Number	Length		CB1615-SA	
CB1615-SA	120 mm	4 3/4"	<p>* 0.3 mm - .011"</p>	
CB1615-AL	120 mm	4 3/4"		
CB1615-BR	120 mm	4 3/4"		
<ul style="list-style-type: none"> • Extra Fine Tip 				

Part Number	Length		CB1616-SA	
CB1616-SA	120 mm	4 3/4"	<p>* 0.4 mm - .015"</p>	
CB1616-AL	120 mm	4 3/4"		
CB1616-BR	120 mm	4 3/4"		
<ul style="list-style-type: none"> • Very Fine Tip 				

Part Number	Length		CB1617-SA	
CB1617-SA	120 mm	4 3/4"	<p>* 1.5 mm - .06"</p>	
CB1617-AL	120 mm	4 3/4"		
CB1617-BR	120 mm	4 3/4"		
<ul style="list-style-type: none"> • Flat Tip 				

CERAMIC QUICK CHANGE TWEEZERS CB1800 series



Made in Switzerland
Patented

With Black ESD Safe Ceramic Tip

- Stainless Antiacid Antimagnetic Handle, add suffix "-SA"
- Aluminum Handle, add suffix "-AL"
- Brass Handle, add suffix "-BR"



CB1804-SA



CB1804-AL



CB1804-BR

Part Number Length CB1802-SA

CB1802-SA	135 mm	5 1/4"
CB1802-AL	135 mm	5 1/4"
CB1802-BR	135 mm	5 1/4"

- Medium Tip



* 1.5 mm - .06"



Part Number Length CB1803-SA

CB1803-SA	127 mm	5"
CB1803-AL	127 mm	5"
CB1803-BR	127 mm	5"

- Strong Flat Tip



* 2.3 mm - .09"



Part Number Length CB1804-SA

CB1804-SA	135 mm	5 1/4"
CB1804-AL	135 mm	5 1/4"
CB1804-BR	135 mm	5 1/4"

- Fine Tip



* 0.7 mm - .027"



CERAMIC QUICK CHANGE TWEEZERS CB1800 series



Made in Switzerland
Patented

With Black ESD Safe Ceramic Tip

- Stainless Antiacid Antimagnetic Handle, add suffix "-SA"
- Aluminum Handle, add suffix "-AL"
- Brass Handle, add suffix "-BR"

Part Number	Length		CB1809-SA	
CB1809-SA	127 mm	5"	<p>* 1.5 mm - .06"</p>	
CB1809-AL	127 mm	5"		
CB1809-BR	127 mm	5"		
<ul style="list-style-type: none"> • Fine Angulated SMD Flat Tip 				

Part Number	Length		CB1810A-SA	
CB1810A-SA	127 mm	5"	<p>* 0.6 mm - .023"</p>	
CB1810A-AL	127 mm	5"		
CB1810A-BR	127 mm	5"		
<ul style="list-style-type: none"> • Very Small Fine Angulated SMD Flat Tip 				

Part Number	Length		CB1815-SA	
CB1815-SA	135 mm	5 1/4"	<p>* 0.3 mm - .011"</p>	
CB1815-AL	135 mm	5 1/4"		
CB1815-BR	135 mm	5 1/4"		
<ul style="list-style-type: none"> • Extra Fine Tip 				

Part Number	Length		CB1816-SA	
CB1816-SA	135 mm	5 1/4"	<p>* 0.4 mm - .015"</p>	
CB1816-AL	135 mm	5 1/4"		
CB1816-BR	135 mm	5 1/4"		
<ul style="list-style-type: none"> • Very Fine Tip 				

Part Number	Length		CB1817-SA	
CB1817-SA	135 mm	5 1/4"	<p>* 1.5 mm - .06"</p>	
CB1817-AL	135 mm	5 1/4"		
CB1817-BR	135 mm	5 1/4"		
<ul style="list-style-type: none"> • Flat Tip 				

CERAMIC QUICK CHANGE TWEEZERS with 45° Bent Handle

CB1300-B series with Black ESD Safe Ceramic Tip

- Stainless Antiacid Antimagnetic Bent Handle, add suffix "-BSA"
- Aluminum Bent Handle, add suffix "-BAL"
- Brass Bent Handle, add suffix "-BBR"



Made in Switzerland
Patented



Part Number Length **CB1302-BSA**

CB1302-BSA	110 mm	4 1/3"
CB1302-BAL	110 mm	4 1/3"
CB1302-BBR	110 mm	4 1/3"

- Medium Tip

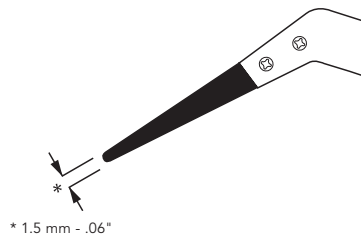

* 1.5 mm - .06"



Part Number Length **CB1303-BSA**

CB1303-BSA	105 mm	4 1/6"
CB1303-BAL	105 mm	4 1/6"
CB1303-BBR	105 mm	4 1/6"

- Strong Flat Tip

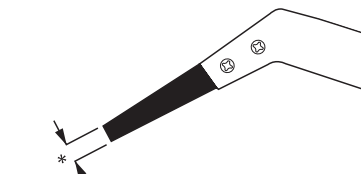

* 2.3 mm - .09"



Part Number Length **CB1304-BSA**

CB1304-BSA	110 mm	4 1/3"
CB1304-BAL	110 mm	4 1/3"
CB1304-BBR	110 mm	4 1/3"

- Fine Tip

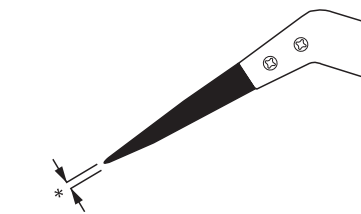

* 0.7 mm - .027"



CERAMIC QUICK CHANGE TWEEZERS with 45° Bent Handle

CB1300-B series with Black ESD Safe Ceramic Tip

- Stainless Antiacid Antimagnetic Bent Handle, add suffix "-BSA"
- Aluminum Bent Handle, add suffix "-BAL"
- Brass Bent Handle, add suffix "-BBR"



Made in Switzerland
Patented

Part Number	Length		CB1309-BSA	
CB1309-BSA	105 mm	4 1/6"	<p>* 1.5 mm - .06"</p>	
CB1309-BAL	105 mm	4 1/6"		
CB1309-BBR	105 mm	4 1/6"		
• Fine Angulated SMD Flat Tip				
Part Number	Length		CB1310A-BSA	
CB1310A-BSA	105 mm	4 1/6"	<p>* 0.6 mm - .023"</p>	
CB1310A-BAL	105 mm	4 1/6"		
CB1310A-BBR	105 mm	4 1/6"		
• Very Small Fine Angulated SMD Flat Tip				
Part Number	Length		CB1315-BSA	
CB1315-BSA	110 mm	4 1/3"	<p>* 0.3 mm - .011"</p>	
CB1315-BAL	110 mm	4 1/3"		
CB1315-BBR	110 mm	4 1/3"		
• Extra Fine Tip				
Part Number	Length		CB1316-BSA	
CB1316-BSA	110 mm	4 1/3"	<p>* 0.4 mm - .015"</p>	
CB1316-BAL	110 mm	4 1/3"		
CB1316-BBR	110 mm	4 1/3"		
• Very Fine Tip				
Part Number	Length		CB1317-BSA	
CB1317-BSA	110 mm	4 1/3"	<p>* 1.5 mm - .06"</p>	
CB1317-BAL	110 mm	4 1/3"		
CB1317-BBR	110 mm	4 1/3"		
• Flat Tip				

CERAMIC QUICK CHANGE TWEEZERS with 45° Bent Handle

CB1600-B series with Black ESD Safe Ceramic Tip

- Stainless Antiacid Antimagnetic Serrated Bent Handle, add suffix "-BSA"
- Aluminum Serrated Bent Handle, add suffix "-BAL"
- Brass Serrated Bent Handle, add suffix "-BBR"



Made in Switzerland
Patented



Part Number	Length		CB1602-BSA	
CB1602-BSA	110 mm	4 1/3"	<p>* 1.5 mm - .06"</p>	
CB1602-BAL	110 mm	4 1/3"		
CB1602-BBR	110 mm	4 1/3"		
<ul style="list-style-type: none"> • Medium Tip 				

Part Number	Length		CB1603-BSA	
CB1603-BSA	105 mm	4 1/6"	<p>* 2.3 mm - .09"</p>	
CB1603-BAL	105 mm	4 1/6"		
CB1603-BBR	105 mm	4 1/6"		
<ul style="list-style-type: none"> • Strong Flat Tip 				

Part Number	Length		CB1604-BSA	
CB1604-BSA	110 mm	4 1/3"	<p>* 0.7 mm - .027"</p>	
CB1604-BAL	110 mm	4 1/3"		
CB1604-BBR	110 mm	4 1/3"		
<ul style="list-style-type: none"> • Fine Tip 				

CERAMIC QUICK CHANGE TWEEZERS with 45° Bent Handle

CB1600-B series with Black ESD Safe Ceramic Tip

- Stainless Antiacid Antimagnetic Serrated Bent Handle, add suffix "-BSA"
- Aluminum Serrated Bent Handle, add suffix "-BAL"
- Brass Serrated Bent Handle, add suffix "-BBR"



Made in Switzerland
Patented

Part Number	Length		CB1609-BSA	
CB1609-BSA	105 mm	4 1/6"	<p>* 1.5 mm - .06"</p>	
CB1609-BAL	105 mm	4 1/6"		
CB1609-BBR	105 mm	4 1/6"		
• Fine Angulated SMD Flat Tip				
Part Number	Length		CB1610A-BSA	
CB1610A-BSA	105 mm	4 1/6"	<p>* 0.6 mm - .023"</p>	
CB1610A-BAL	105 mm	4 1/6"		
CB1610A-BBR	105 mm	4 1/6"		
• Very Small Fine Angulated SMD Flat Tip				
Part Number	Length		CB1615-BSA	
CB1615-BSA	110 mm	4 1/3"	<p>* 0.3 mm - .011"</p>	
CB1615-BAL	110 mm	4 1/3"		
CB1615-BBR	110 mm	4 1/3"		
• Extra Fine Tip				
Part Number	Length		CB1616-BSA	
CB1616-BSA	110 mm	4 1/3"	<p>* 0.4 mm - .015"</p>	
CB1616-BAL	110 mm	4 1/3"		
CB1616-BBR	110 mm	4 1/3"		
• Very Fine Tip				
Part Number	Length		CB1617-BSA	
CB1617-BSA	110 mm	4 1/3"	<p>* 1.5 mm - .06"</p>	
CB1617-BAL	110 mm	4 1/3"		
CB1617-BBR	110 mm	4 1/3"		
• Flat Tip				

CERAMIC QUICK CHANGE TWEEZERS with 45° Bent Handle

CB1800-B series with Black ESD Safe Ceramic Tip

- Stainless Antiacid Antimagnetic Bent Handle, add suffix "-BSA"
- Aluminum Bent Handle, add suffix "-BAL"
- Brass Bent Handle, add suffix "-BBR"



Made in Switzerland
Patented



Part Number Length **CB1802-BSA**

CB1802-BSA	120 mm	4 3/4"
CB1802-BAL	120 mm	4 3/4"
CB1802-BBR	120 mm	4 3/4"

- Medium Tip

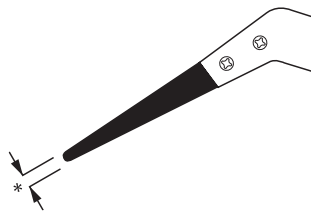

Part Number Length **CB1803-BSA**

CB1803-BSA	115 mm	4 1/2"
CB1803-BAL	115 mm	4 1/2"
CB1803-BBR	115 mm	4 1/2"

- Strong Flat Tip

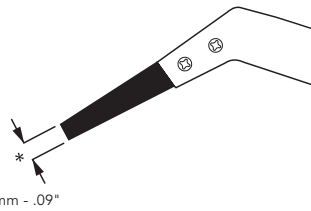

Part Number Length **CB1804-BSA**

CB1804-BSA	120 mm	4 3/4"
CB1804-BAL	120 mm	4 3/4"
CB1804-BBR	120 mm	4 3/4"

- Fine Tip

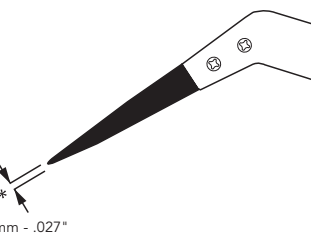

CERAMIC QUICK CHANGE TWEEZERS with 45° Bent Handle

CB1800-B series with Black ESD Safe Ceramic Tip

- Stainless Antiacid Antimagnetic Bent Handle, add suffix "-BSA"
- Aluminum Bent Handle, add suffix "-BAL"
- Brass Bent Handle, add suffix "-BBR"



Made in Switzerland
Patented

Part Number	Length		CB1809-BSA	
CB1809-BSA	115 mm	4 1/2"	<p>* 1.5 mm - .06"</p>	
CB1809-BAL	115 mm	4 1/2"		
CB1809-BBR	115 mm	4 1/2"		
• Fine Angulated SMD Flat Tip				
Part Number	Length		CB1810A-BSA	
CB1810A-BSA	115 mm	4 1/2"	<p>* 0.6 mm - .023"</p>	
CB1810A-BAL	115 mm	4 1/2"		
CB1810A-BBR	115 mm	4 1/2"		
• Very Small Fine Angulated SMD Flat Tip				
Part Number	Length		CB1815-BSA	
CB1815-BSA	120 mm	4 3/4"	<p>* 0.3 mm - .011"</p>	
CB1815-BAL	120 mm	4 3/4"		
CB1815-BBR	120 mm	4 3/4"		
• Extra Fine Tip				
Part Number	Length		CB1816-BSA	
CB1816-BSA	120 mm	4 3/4"	<p>* 0.4 mm - .015"</p>	
CB1816-BAL	120 mm	4 3/4"		
CB1816-BBR	120 mm	4 3/4"		
• Very Fine Tip				
Part Number	Length		CB1817-BSA	
CB1817-BSA	120 mm	4 3/4"	<p>* 1.5 mm - .06"</p>	
CB1817-BAL	120 mm	4 3/4"		
CB1817-BBR	120 mm	4 3/4"		
• Flat Tip				

White Antistatic and Black ESD Safe Ceramic Tips for CERAMIC QUICK CHANGE Tweezers



Made in Switzerland
Patented

• TIP-CW-... White Antistatic Ceramic



• TIP-CB-... Black ESD Safe Ceramic



TIP-CW-2
TIP-CB-2

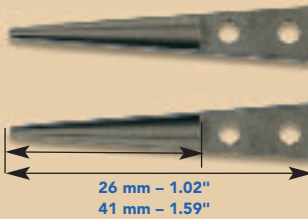

TIP-CW-3
TIP-CB-3

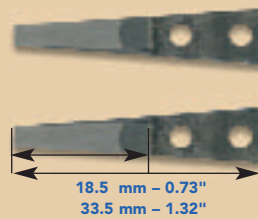

TIP-CW-4
TIP-CB-4

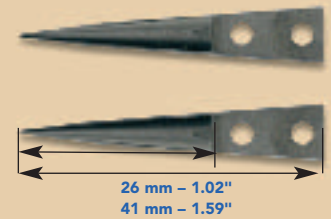

TIP-CW-9
TIP-CB-9

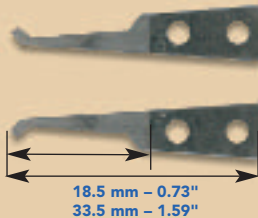

TIP-CW-10A
TIP-CB-10A

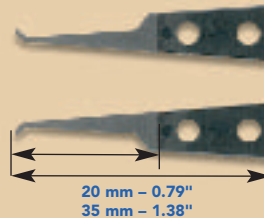

TIP-CW-15
TIP-CB-15

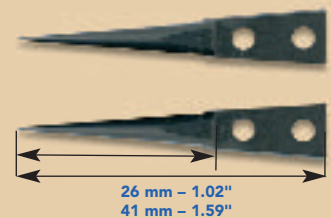

TIP-CW-16
TIP-CB-16

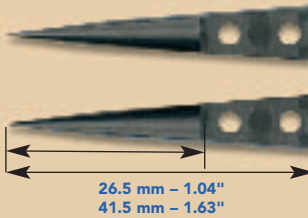

TIP-CW-17
TIP-CB-17

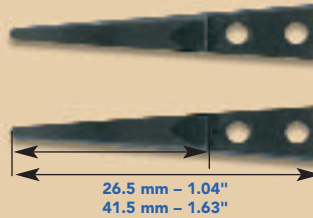

All Tips Shown Above Fit on Straight Handles and New 45° Bent Handles.
See pages 77-79







Except: T5000-SA / RT5000-SA
TS5000-SA / RTS5000-SA
1300-SA-EZ / R1300-SA-EZ

QUICK CHANGE TWEEZERS' Handles - See pages 4-5

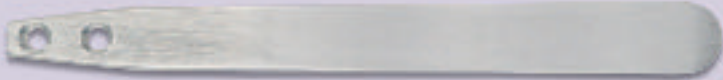
- Stainless Antiacid Antimagnetic, suffix "-SA"
- Aluminum, suffix "-AL"
- Brass, suffix "-BR"
- Available for all Tips: Black ESD Safe, STD Grey Static Dissipative, White DELRIN 500, White Antistatic Ceramic, Black ESD Safe Ceramic



Made in
Switzerland
Patented

<p>1300-SA 95 mm - 3 3/4" Stainless Antiacid Antimagnetic</p>	
<p>1300-AL 95 mm - 3 3/4" Aluminum</p>	
<p>1300-BR 95 mm - 3 3/4" Brass</p>	
<p>R1300-SA 95 mm - 3 3/4" Stainless Antiacid Antimagnetic • Reverse Action</p>	
<p>1300C-SA 85 mm - 3 1/4" Stainless Antiacid Antimagnetic</p>	
<p>R1300C-SA 85 mm - 3 1/4" Stainless Antiacid Antimagnetic • Reverse Action</p>	
<p>1600-SA 95 mm - 3 3/4" Stainless Antiacid Antimagnetic</p>	
<p>1600-AL 95 mm - 3 3/4" Aluminum</p>	

Each HANDLE Above Comes With
4 Corresponding SCREWS (2 pairs)

Adjustable Screw Pressure is Available on all Reverse
Action Tweezers. Add suffix "-AP", (ex. R1302-SA-AP)
See page 1

QUICK CHANGE TWEEZERS' Handles - See pages 4-5

- Stainless Antiacid Antimagnetic, suffix "-SA"
- Aluminum, suffix "-AL"
- Brass, suffix "-BR"
- Available for all Tips: Black ESD Safe, STD Grey Static Dissipative, White DELRIN 500, White Antistatic Ceramic, Black ESD Safe Ceramic



Made in Switzerland
Patented

<p>1600-BR Brass</p>	<p>95 mm - 3 3/4"</p>	
<p>1800-SA Stainless Antiacid Antimagnetic</p>	<p>110 mm - 4 1/3"</p>	
<p>1800-AL Aluminum</p>	<p>110 mm - 4 1/3"</p>	
<p>1800-BR Brass</p>	<p>110 mm - 4 1/3"</p>	
<p>1300-SA-EZ R1300-SA-EZ Stainless Antiacid Antimagnetic with Patented EZ Lever • For 1390W-SA / 1490W-SA</p>	<p>95 mm - 3 3/4"</p>	 <p>• Regular or Reverse Action</p>
<p>T5000-SA RT5000-SA Stainless Antiacid Antimagnetic with Patented EZ Lever • For T5508-SA / T5608-SA, T5531-SA T5631-SA, T5508W-SA / T5608W-SA</p>	<p>120 mm - 4 3/4"</p>	 <p>• Regular or Reverse Action</p>
<p>TS5000-SA RTS5000-SA Stainless Antiacid Antimagnetic with Patented EZ Lever • For T5509W-SA / T5609W-SA, T5510W-SA T5610W-SA</p>	<p>120 mm - 4 3/4"</p>	 <p>• Serrated Handle, Regular or Reverse Action</p>

Each HANDLE Above Comes With 4 Corresponding SCREWS (2 pairs)

Adjustable Screw Pressure is Available on all Reverse Action Tweezers. Add suffix "-AP", (ex. R1302-SA-AP) See page 1

QUICK CHANGE TWEEZERS' 45° BENT Handles - See pages 4-5

- Stainless Antiacid Antimagnetic, suffix "-BSA"
- Aluminum, suffix "-BAL"
- Brass, suffix "-BBR"
- Available for all Tips: Black ESD Safe, STD Grey Static Dissipative, White DELRIN 500, White Antistatic Ceramic, Black ESD Safe Ceramic



Made in Switzerland
Patented

1300-BSA 90 mm - 3 1/2"
Stainless Antiacid Antimagnetic
45° Angulated

1300-BAL 90 mm - 3 1/2"
Aluminum 45° Angulated

1300-BBR 90 mm - 3 1/2"
Brass 45° Angulated



1600-BSA 90 mm - 3 1/2"
Stainless Antiacid Antimagnetic
45° Angulated

1600-BAL 90 mm - 3 1/2"
Aluminum 45° Angulated

1600-BBR 90 mm - 3 1/2"
Brass 45° Angulated



1800-BSA 105 mm - 4 1/6"
Stainless Antiacid Antimagnetic
45° Angulated

1800-BAL 105 mm - 4 1/6"
Aluminum 45° Angulated

1800-BBR 105 mm - 4 1/6"
Brass 45° Angulated



Each HANDLE Above Comes With 4 Corresponding SCREWS (2 pairs)

Part #	Page #	Part #	Page #	Part #	Page #
1300-AL	4 - 77	1306C-SA	26	1317B-BSA	32
1300-BAL	4 - 79	1306C-SA-STD	26	1317B-BSA-STD	32
1300-BBR	4 - 79	1306-SA	6	1317BC-SA	27
1300-BR	4 - 77	1306-SA-STD	6	1317BC-SA-STD	27
1300-BSA	4 - 79	1309-AL	11	1317-BR	13
1300C-SA	4 - 77	1309-AL-STD	11	1317-BR-STD	13
1300-SA	4 - 77	1309-BAL	31	1317-BSA	32
1300-SA-EZ	4 - 78	1309-BAL-STD	31	1317B-SA	7
1302-AL	10	1309-BBR	31	1317-BSA-STD	32
1302-AL-STD	10	1309-BBR-STD	31	1317B-SA-STD	7
1302-BAL	30	1309-BR	13	1317C-SA	27
1302-BAL-STD	30	1309-BR-STD	13	1317C-SA-STD	27
1302-BBR	30	1309-BSA	31	1317-SA	7
1302-BBR-STD	30	1309-BSA-STD	31	1317-SA-STD	7
1302-BR	12	1309C-SA	27	1318-AL	11
1302-BR-STD	12	1309C-SA-STD	27	1318-AL-STD	11
1302-BSA	30	1309-SA	7	1318-BAL	32
1302-BSA-STD	30	1309-SA-STD	7	1318-BAL-STD	32
1302C-SA	26	1310A-AL	11	1318-BBR	32
1302C-SA-STD	26	1310A-AL-STD	11	1318-BBR-STD	32
1302-SA	6	1310A-BAL	31	1318-BR	13
1302-SA-STD	6	1310A-BAL-STD	31	1318-BR-STD	13
1303-AL	10	1310A-BBR	31	1318-BSA	32
1303-AL-STD	10	1310A-BBR-STD	31	1318-BSA-STD	32
1303-BAL	30	1310A-BR	13	1318C-SA	27
1303-BAL-STD	30	1310A-BR-STD	13	1318C-SA-STD	27
1303-BBR	30	1310A-BSA	31	1318H-SA	8
1303-BBR-STD	30	1310A-BSA-STD	31	1318H-SA-STD	8
1303-BR	12	1310AC-SA	27	1318-SA	7
1303-BR-STD	12	1310AC-SA-STD	27	1318-SA-STD	7
1303-BSA	30	1310A-SA	7	1318V-SA	8
1303-BSA-STD	30	1310A-SA-STD	7	1318V-SA-STD	8
1303C-SA	26	1315-AL	11	1319H-SA	8
1303C-SA-STD	26	1315-AL-STD	11	1319H-SA-STD	8
1303-SA	6	1315-BAL	31	1320A-SA(45°)	8
1303-SA-STD	6	1315-BAL-STD	31	1320A-SA-STD(45°)	8
1304-AL	10	1315-BBR	31	1320-SA	8
1304-AL-STD	10	1315-BBR-STD	31	1320-SA-STD	8
1304-BAL	30	1315-BR	13	1322A-SA(45°)	8
1304B-AL	10	1315-BR-STD	13	1322A-SA-STD(45°)	8
1304-BAL-STD	30	1315-BSA	31	1322-SA	8
1304B-AL-STD	10	1315-BSA-STD	31	1322-SA-STD	8
1304B-BAL	31	1315C-SA	27	1323C-SA	8
1304B-BAL-STD	31	1315C-SA-STD	27	1323C-SA-STD	8
1304B-BBR	31	1315-SA	7	1324-AL	11
1304B-BBR-STD	31	1315-SA-STD	7	1324-AL-STD	11
1304-BBR	30	1316-AL	11	1324-BAL	32
1304B-BR	12	1316-AL-STD	11	1324-BAL-STD	32
1304-BBR-STD	30	1316-BAL	32	1324-BBR	32
1304B-BR-STD	12	1316-BAL-STD	32	1324-BBR-STD	32
1304B-BSA	31	1316-BBR	32	1324-BR	13
1304B-BSA-STD	31	1316-BBR-STD	32	1324-BR-STD	13
1304BC-SA	26	1316-BR	13	1324-BSA	32
1304BC-SA-STD	26	1316-BR-STD	13	1324-BSA-STD	32
1304-BR	12	1316-BSA	32	1324C-SA	27
1304-BR-STD	12	1316-BSA-STD	32	1324C-SA-STD	27
1304-BSA	30	1316C-SA	27	1324-SA	7
1304B-SA	6	1316C-SA-STD	27	1324-SA-STD	7
1304-BSA-STD	30	1316-SA	7	1350-SA	8
1304B-SA-STD	6	1316-SA-STD	7	1350-SA-STD	8
1304C-SA	26	1317-AL	11	1351-SA	9
1304C-SA-STD	26	1317-AL-STD	11	1351-SA-STD	9
1304-SA	6	1317-BAL	32	1352-SA	9
1304-SA-STD	6	1317B-AL	11	1352-SA-STD	9
1306-AL	10	1317-BAL-STD	32	1353-SA	9
1306-AL-STD	10	1317B-AL-STD	11	1353-SA-STD	9
1306-BAL	31	1317B-BAL	32	1354-SA	9
1306-BAL-STD	31	1317B-BAL-STD	32	1354-SA-STD	9
1306-BBR	31	1317B-BBR	32	1355-SA	9
1306-BBR-STD	31	1317B-BBR-STD	32	1355-SA-STD	9
1306-BR	12	1317-BBR	32	1356-SA	9
1306-BR-STD	12	1317B-BR	13	1356-SA-STD	9
1306-BSA	31	1317-BBR-STD	32	1357-SA	9
1306-BSA-STD	31	1317B-BR-STD	13	1357-SA-STD	9

Part #	Page #	Part #	Page #	Part #	Page #
1390W-SA	28	1417-BR	13	1604B-BBR	34
1390W-SA-STD	28	1417-BSA	32	1604B-BBR-STD	34
1402-AL	10	1417B-SA	7	1604-BBR	33
1402-BAL	30	1417C-SA	27	1604B-BR	18
1402-BBR	30	1417-SA	7	1604-BBR-STD	33
1402-BR	12	1418-AL	11	1604B-BR-STD	18
1402-BSA	30	1418-BAL	32	1604B-BSA	34
1402C-SA	26	1418-BBR	32	1604B-BSA-STD	34
1402-SA	6	1418-BR	13	1604-BR	18
1403-AL	10	1418-BSA	32	1604-BR-STD	18
1403-BAL	30	1418C-SA	27	1604-BSA	33
1403-BBR	30	1418H-SA	8	1604B-SA	14
1403-BR	12	1418-SA	7	1604-BSA-STD	33
1403-BSA	30	1418V-SA	8	1604B-SA-STD	14
1403C-SA	26	1419H-SA	8	1604-SA	14
1403-SA	6	1420A-SA(45°)	8	1604-SA-STD	14
1404-AL	10	1420-SA	8	1606-AL	16
1404-BAL	30	1422A-SA(45°)	8	1606-AL-STD	16
1404B-AL	10	1422-SA	8	1606-BAL	34
1404B-BAL	31	1423C-SA	8	1606-BAL-STD	34
1404B-BBR	31	1424-AL	11	1606-BBR	34
1404-BBR	30	1424-BAL	32	1606-BBR-STD	34
1404B-BR	12	1424-BBR	32	1606-BR	18
1404B-BSA	31	1424-BR	13	1606-BR-STD	18
1404BC-SA	26	1424-BSA	32	1606-BSA	34
1404-BR	12	1424C-SA	27	1606-BSA-STD	34
1404-BSA	30	1424-SA	7	1606-SA	14
1404B-SA	6	1450-SA	8	1606-SA-STD	14
1404C-SA	26	1451-SA	9	1609-AL	17
1404-SA	6	1452-SA	9	1609-AL-STD	17
1406-AL	10	1453-SA	9	1609-BAL	34
1406-BAL	31	1454-SA	9	1609-BAL-STD	34
1406-BBR	31	1455-SA	9	1609-BBR	34
1406-BR	12	1456-SA	9	1609-BBR-STD	34
1406-BSA	31	1457-SA	9	1609-BR	19
1406C-SA	26	1490W-SA	28	1609-BR-STD	19
1406-SA	6	1600-AL	4 - 77	1609-BSA	34
1409-AL	11	1600-BAL	4 - 79	1609-BSA-STD	34
1409-BAL	31	1600-BBR	4 - 79	1609-SA	15
1409-BBR	31	1600-BR	4 - 78	1609-SA-STD	15
1409-BR	13	1600-BSA	4 - 79	1610A-AL	17
1409-BSA	31	1600-SA	4 - 77	1610A-AL-STD	17
1409C-SA	27	1602-AL	16	1610A-BAL	34
1409-SA	7	1602-AL-STD	16	1610A-BAL-STD	34
1410A-AL	11	1602-BAL	33	1610A-BBR	34
1410A-BAL	31	1602-BAL-STD	33	1610A-BBR-STD	34
1410A-BBR	31	1602-BBR	33	1610A-BR	19
1410A-BR	13	1602-BBR-STD	33	1610A-BR-STD	19
1410A-BSA	31	1602-BR	18	1610A-BSA	34
1410AC-SA	27	1602-BR-STD	18	1610A-BSA-STD	34
1410A-SA	7	1602-BSA	33	1610A-SA	15
1415-AL	11	1602-BSA-STD	33	1610A-SA-STD	15
1415-BAL	31	1602-SA	14	1615-AL	17
1415-BBR	31	1602-SA-STD	14	1615-AL-STD	17
1415-BR	13	1603-AL	16	1615-BAL	34
1415-BSA	31	1603-AL-STD	16	1615-BAL-STD	34
1415C-SA	27	1603-BAL	33	1615-BBR	34
1415-SA	7	1603-BAL-STD	33	1615-BBR-STD	34
1416-AL	11	1603-BBR	33	1615-BR	19
1416-BAL	32	1603-BBR-STD	33	1615-BR-STD	19
1416-BBR	32	1603-BR	18	1615-BSA	34
1416-BR	13	1603-BR-STD	18	1615-BSA-STD	34
1416-BSA	32	1603-BSA	33	1615-SA	15
1416C-SA	27	1603-BSA-STD	33	1615-SA-STD	15
1416-SA	7	1603-SA	14	1616-AL	17
1417-AL	11	1603-SA-STD	14	1616-AL-STD	17
1417-BAL	32	1604-AL	16	1616-BAL	35
1417B-AL	11	1604-AL-STD	16	1616-BAL-STD	35
1417B-BAL	32	1604-BAL	33	1616-BBR	35
1417B-BBR	32	1604B-AL	16	1616-BBR-STD	35
1417-BBR	32	1604-BAL-STD	33	1616-BR	19
1417B-BR	13	1604B-AL-STD	16	1616-BR-STD	19
1417B-BSA	32	1604B-BAL	34	1616-BSA	35
1417BC-SA	27	1604B-BAL-STD	34	1616-BSA-STD	35

Part #	Page #	Part #	Page #	Part #	Page #
1616-SA	15	1706-AL	16	1803-BAL	36
1616-SA-STD	15	1706-BAL	34	1803-BAL-STD	36
1617-AL	17	1706-BBR	34	1803-BBR	36
1617-AL-STD	17	1706-BR	18	1803-BBR- STD	36
1617-BAL	35	1706-BSA	34	1803-BR	24
1617B-AL	17	1706-SA	14	1803-BR-STD	24
1617-BAL-STD	35	1709-AL	17	1803-BSA	36
1617B-AL-STD	17	1709-BAL	34	1803-BSA-STD	36
1617B-BAL	35	1709-BBR	34	1803-SA	20
1617B-BAL-STD	35	1709-BR	19	1803-SA-STD	20
1617B-BBR	35	1709-BSA	34	1804-AL	22
1617B-BBR-STD	35	1709-SA	15	1804-AL-STD	22
1617-BBR	35	1710A-AL	17	1804-BAL	36
1617B-BR	19	1710A-BAL	34	1804B-BAL	22
1617-BBR-STD	35	1710A-BBR	34	1804-BAL-STD	36
1617B-BR-STD	19	1710A-BR	19	1804B-AL-STD	22
1617B-BSA	35	1710A-BSA	34	1804B-BAL	37
1617B-BSA-STD	35	1710A-SA	15	1804B-BAL-STD	37
1617-BR	19	1715-AL	17	1804B-BBR	37
1617-BR-STD	19	1715-BAL	34	1804B-BBR-STD	37
1617-BSA	35	1715-BBR	34	1804-BBR	36
1617B-SA 1	5	1715-BR	19	1804B-BR	24
1617-BSA-STD	35	1715-BSA	34	1804-BBR-STD	36
1617B-SA-STD	15	1715-SA	15	1804B-BR-STD	24
1617-SA	15	1716-AL	17	1804B-BSA	37
1617-SA-STD	15	1716-BAL	35	1804B-BSA-STD	37
1618-AL	17	1716-BBR	35	1804-BR	24
1618-AL-STD	17	1716-BR	19	1804-BR-STD	24
1618-BAL	35	1716-BSA	35	1804-BSA	36
1618-BAL-STD	35	1716-SA	15	1804B-SA	20
1618-BBR	35	1717-AL	17	1804-BSA-STD	36
1618-BBR-STD	35	1717-BAL	35	1804B-SA-STD	20
1618-BR	19	1717B-AL	17	1804-SA	20
1618-BR-STD	19	1717B-BAL	35	1804-SA-STD	20
1618-BSA	35	1717B-BBR	35	1806-AL	22
1618-BSA-STD	35	1717-BBR	35	1806-AL-STD	22
1618-SA	15	1717B-BR	19	1806-BAL	37
1618-SA-STD	15	1717B-BSA	35	1806-BAL-STD	37
1624-AL	17	1717-BR	19	1806-BBR	37
1624-AL-STD	17	1717-BSA	35	1806-BBR-STD	37
1624-BAL	35	1717B-SA	15	1806-BR	24
1624-BAL-STD	35	1717-SA	15	1806-BR-STD	24
1624-BBR	35	1718-AL	17	1806-BSA	37
1624-BBR-STD	35	1718-BAL	35	1806-BSA-STD	37
1624-BR	19	1718-BBR	35	1806-SA	20
1624-BR-STD	19	1718-BR	19	1806-SA-STD	20
1624-BSA	35	1718-BSA	35	1809-AL	23
1624-BSA-STD	35	1718-SA	15	1809-AL-STD	23
1624-SA	15	1724-AL	17	1809-BAL	37
1624-SA-STD	15	1724-BAL	35	1809-BAL-STD	37
1702-AL	16	1724-BBR	35	1809-BBR	37
1702-BAL	33	1724-BR	19	1809-BBR-STD	37
1702-BBR	33	1724-BSA	35	1809-BR	25
1702-BR	18	1724-SA	15	1809-BR-STD	25
1702-BSA	33	1800-AL	4 - 78	1809-BSA	37
1702-SA	14	1800-BAL	4 - 79	1809-BSA-STD	37
1703-AL	16	1800-BBR	4 - 79	1809-SA	21
1703-BAL	33	1800-BR	4 - 78	1809-SA-STD	21
1703-BBR	33	1800-BSA	4 - 79	1810A-AL	23
1703-BR	18	1800-SA	4 - 78	1810A-AL-STD	23
1703-BSA	33	1802-AL	22	1810A-BAL	37
1703-SA	14	1802-AL-STD	22	1810A-BAL-STD	37
1704-AL	16	1802-BAL	36	1810A-BBR	37
1704-BAL	33	1802-BAL-STD	36	1810A-BBR-STD	37
1704B-AL	16	1802-BBR	36	1810A-BR	25
1704B-BAL	34	1802-BBR-STD	36	1810A-BR-STD	25
1704B-BBR	34	1802-BR	24	1810A-BSA	37
1704-BBR	33	1802-BR-STD	24	1810A-BSA-STD	37
1704B-BR	18	1802-BSA	36	1810A-SA	21
1704B-BSA	34	1802-BSA-STD	36	1810A-SA-STD	21
1704-BR	18	1802-SA	20	1815-AL	23
1704-BSA	33	1802-SA-STD	20	1815-AL-STD	23
1704B-SA	14	1803-AL	22	1815-BAL	37
1704-SA	14	1803-AL-STD	22	1815-BAL-STD	37

Part #	Page #	Part #	Page #	Part #	Page #
1815-BBR	37	1903-AL	22	300-SA	43
1815-BBR-STD	37	1903-BAL	36	302-SA	39
1815-BR	25	1903-BBR	36	302-SA-STD	39
1815-BR-STD	25	1903-BR	24	303-SA	39
1815-BSA	37	1903-BSA	36	303-SA-STD	39
1815-BSA-STD	37	1903-SA	20	304B-SA	39
1815-SA	21	1904-AL	22	304B-SA-STD	39
1815-SA-STD	21	1904-BAL	36	304C-SA	39
1816-AL	23	1904B-AL	22	304C-SA-STD	39
1816-AL-STD	23	1904B-BAL	37	304-SA	39
1816-BAL	38	1904B-BBR	37	304-SA-STD	39
1816-BAL-STD	38	1904-BBR	36	306-SA	40
1816-BBR	38	1904B-BR	24	306-SA-STD	40
1816-BBR-STD	38	1904B-BSA	37	309-SA	40
1816-BR	25	1904-BR	24	309-SA-STD	40
1816-BR-STD	25	1904-BSA	36	310A-SA	40
1816-BSA	38	1904B-SA	20	310A-SA-STD	40
1816-BSA-STD	38	1904-SA	20	315-SA	40
1816-SA	21	1906-AL	22	315-SA-STD	40
1816-SA-STD	21	1906-BAL	37	316-SA	40
1817-AL	23	1906-BBR	37	316-SA-STD	40
1817-AL-STD	23	1906-BR	24	317B-SA	40
1817-BAL	38	1906-BSA	37	317B-SA-STD	40
1817B-AL	23	1906-SA	20	317-SA	40
1817-BAL-STD	38	1909-AL	23	317-SA-STD	40
1817B-AL-STD	23	1909-BAL	37	318H-SA	41
1817B-BAL	38	1909-BBR	37	318H-SA-STD	41
1817B-BAL-STD	38	1909-BR	25	318-SA	40
1817B-BBR	38	1909-BSA	37	318-SA-STD	40
1817B-BBR-STD	38	1909-SA	21	318V-SA	41
1817-BBR	38	1910A-AL	23	318V-SA-STD	41
1817B-BR	25	1910A-BAL	37	319H-SA	41
1817-BBR-STD	38	1910A-BBR	37	319H-SA-STD	41
1817B-BR-STD	25	1910A-BR	25	320A-SA(45°)	41
1817B-BSA	38	1910A-BSA	37	320A-SA-STD(45°)	41
1817B-BSA-STD	38	1910A-SA	21	320-SA	41
1817-BR	25	1915-AL	23	320-SA-STD	41
1817-BR-STD	25	1915-BAL	37	322A-SA(45°)	41
1817-BSA	38	1915-BBR	37	322A-SA-STD(45°)	41
1817B-SA	21	1915-BR	25	322-SA	41
1817-BSA-STD	38	1915-BSA	37	322-SA-STD	41
1817B-SA-STD	21	1915-SA	21	323C-SA	41
1817-SA	21	1916-AL	23	323C-SA-STD	41
1817-SA-STD	21	1916-BAL	38	324-SA	41
1818-AL	23	1916-BBR	38	324-SA-STD	41
1818-AL-STD	23	1916-BR	25	350-SA	42
1818-BAL	38	1916-BSA	38	350-SA-STD	42
1818-BAL-STD	38	1916-SA	21	351-SA	42
1818-BBR	38	1917-AL	23	351-SA-STD	42
1818-BBR-STD	38	1917-BAL	38	352-SA	42
1818-BR	25	1917B-AL	23	352-SA-STD	42
1818-BR-STD	25	1917B-BAL	38	353-SA	42
1818-BSA	38	1917B-BBR	38	353-SA-STD	42
1818-BSA-STD	38	1917-BBR	38	354-SA	42
1818-SA	21	1917B-BR	25	354-SA-STD	42
1818-SA-STD	21	1917B-BSA	38	355-SA	42
1824-AL	23	1917-BR	25	355-SA-STD	42
1824-AL-STD	23	1917-BSA	38	356-SA	42
1824-BAL	38	1917B-SA	21	356-SA-STD	42
1824-BAL-STD	38	1917-SA	21	357-SA	42
1824-BBR	38	1918-AL	23	357-SA-STD	42
1824-BBR-STD	38	1918-BAL	38	402-SA	39
1824-BR	25	1918-BBR	38	403-SA	39
1824-BR-STD	25	1918-BR	25	404B-SA	39
1824-BSA	38	1918-BSA	38	404C-SA	39
1824-BSA-STD	38	1918-SA	21	404-SA	39
1824-SA	21	1924-AL	23	406-SA	40
1824-SA-STD	21	1924-BAL	38	409-SA	40
1902-AL	22	1924-BBR	38	410A-SA	40
1902-BAL	36	1924-BR	25	415-SA	40
1902-BBR	36	1924-BSA	38	416-SA	40
1902-BR	24	1924-SA	21	417B-SA	40
1902-BSA	36	300AF-SA	43	417-SA	40
1902-SA	20	300F-SA	43	418H-SA	41

Part #	Page #	Part #	Page #	Part #	Page #
418-SA	40	CB1602-BAL	72	CB1810A-BR	69
418V-SA	41	CB1602-BBR	72	CB1810A-BSA	75
419H-SA	41	CB1602-BR	66	CB1810A-SA	69
420A-SA	41	CB1602-BSA	72	CB1815-AL	69
420-SA	41	CB1602-SA	66	CB1815-BAL	75
422A-SA	41	CB1603-AL	66	CB1815-BBR	75
422-SA	41	CB1603-BAL	72	CB1815-BR	69
423C-SA	41	CB1603-BBR	72	CB1815-BSA	75
424-SA	41	CB1603-BR	66	CB1815-SA	69
450-SA	42	CB1603-BSA	72	CB1816-AL	69
451-SA	42	CB1603-SA	66	CB1816-BAL	75
452-SA	42	CB1604-AL	66	CB1816-BBR	75
453-SA	42	CB1604-BAL	72	CB1816-BR	69
454-SA	42	CB1604-BBR	72	CB1816-BSA	75
455-SA	42	CB1604-BR	66	CB1816-SA	69
456-SA	42	CB1604-BSA	72	CB1817-AL	69
457-SA	42	CB1604-SA	66	CB1817-BAL	75
CB1302-AL	64	CB1609-AL	67	CB1817-BBR	75
CB1302-BAL	70	CB1609-BAL	73	CB1817-BR	69
CB1302-BBR	70	CB1609-BBR	73	CB1817-BSA	75
CB1302-BR	64	CB1609-BR	67	CB1817-SA	69
CB1302-BSA	70	CB1609-BSA	73	CW1302-AL	52
CB1302C-SA	64	CB1609-SA	67	CW1302-BAL	58
CB1302-SA	64	CB1610A-AL	67	CW1302-BBR	58
CB1303-AL	64	CB1610A-BAL	73	CW1302-BR	52
CB1303-BAL	70	CB1610A-BBR	73	CW1302-BSA	58
CB1303-BBR	70	CB1610A-BR	67	CW1302C-SA	52
CB1303-BR	64	CB1610A-BSA	73	CW1302-SA	52
CB1303-BSA	70	CB1610A-SA	67	CW1303-AL	52
CB1303C-SA	64	CB1615-AL	67	CW1303-BAL	58
CB1303-SA	64	CB1615-BAL	73	CW1303-BBR	58
CB1304-AL	64	CB1615-BBR	73	CW1303-BR	52
CB1304-BAL	70	CB1615-BR	67	CW1303-BSA	58
CB1304-BBR	70	CB1615-BSA	73	CW1303C-SA	52
CB1304-BR	64	CB1615-SA	67	CW1303-SA	52
CB1304-BSA	70	CB1616-AL	67	CW1304-AL	52
CB1304C-SA	64	CB1616-BAL	73	CW1304-BAL	58
CB1304-SA	64	CB1616-BBR	73	CW1304-BBR	58
CB1309-AL	65	CB1616-BR	67	CW1304-BR	52
CB1309-BAL	71	CB1616-BSA	73	CW1304-BSA	58
CB1309-BBR	71	CB1616-SA	67	CW1304C-SA	52
CB1309-BR	65	CB1617-AL	67	CW1304-SA	52
CB1309-BSA	71	CB1617-BAL	73	CW1309-AL	53
CB1309C-SA	65	CB1617-BBR	73	CW1309-BAL	59
CB1309-SA	65	CB1617-BR	67	CW1309-BBR	59
CB1310A-AL	65	CB1617-BSA	73	CW1309-BR	53
CB1310A-BAL	71	CB1617-SA	67	CW1309-BSA	59
CB1310A-BBR	71	CB1802-AL	68	CW1309C-SA	53
CB1310A-BR	65	CB1802-BAL	74	CW1309-SA	53
CB1310A-BSA	71	CB1802-BBR	74	CW1310A-AL	53
CB1310AC-SA	65	CB1802-BR	68	CW1310A-BAL	59
CB1310A-SA	65	CB1802-BSA	74	CW1310A-BBR	59
CB1315-AL	65	CB1802-SA	68	CW1310A-BR	53
CB1315-BAL	71	CB1803-AL	68	CW1310A-BSA	59
CB1315-BBR	71	CB1803-BAL	74	CW1310AC-SA	53
CB1315-BR	65	CB1803-BBR	74	CW1310A-SA	53
CB1315-BSA	71	CB1803-BR	68	CW1315-AL	53
CB1315C-SA	65	CB1803-BSA	74	CW1315-BAL	59
CB1315-SA	65	CB1803-SA	68	CW1315-BBR	59
CB1316-AL	65	CB1804-AL	68	CW1315-BR	53
CB1316-BAL	71	CB1804-BAL	74	CW1315-BSA	59
CB1316-BBR	71	CB1804-BBR	74	CW1315C-SA	53
CB1316-BR	65	CB1804-BR	68	CW1315-SA	53
CB1316-BSA	71	CB1804-BSA	74	CW1316-AL	53
CB1316C-SA	65	CB1804-SA	68	CW1316-BAL	59
CB1316-SA	65	CB1809-AL	69	CW1316-BBR	59
CB1317-AL	65	CB1809-BAL	75	CW1316-BR	53
CB1317-BAL	71	CB1809-BBR	75	CW1316-BSA	59
CB1317-BBR	71	CB1809-BR	69	CW1316C-SA	53
CB1317-BR	65	CB1809-BSA	75	CW1316-SA	53
CB1317-BSA	71	CB1809-SA	69	CW1317-AL	53
CB1317C-SA	65	CB1810A-AL	69	CW1317-BAL	59
CB1317-SA	65	CB1810A-BAL	75	CW1317-BBR	59
CB1602-AL	66	CB1810A-BBR	75	CW1317-BR	53

Part #	Page #	Part #	Page #	Part #	Page #
CW1317-BSA	59	CW1809-SA	57	TIP-CB-17	76
CW1317C-SA	53	CW1810A-AL	57	TIP-CB-2	76
CW1317-SA	53	CW1810A-BAL	63	TIP-CB-3	76
CW1602-AL	54	CW1810A-BBR	63	TIP-CB-4	76
CW1602-BAL	60	CW1810A-BR	57	TIP-CB-9	76
CW1602-BBR	60	CW1810A-BSA	63	TIP-CW-10A	76
CW1602-BR	54	CW1810A-SA	57	TIP-CW-15	76
CW1602-BSA	60	CW1815-AL	57	TIP-CW-16	76
CW1602-SA	54	CW1815-BAL	63	TIP-CW-17	76
CW1603-AL	54	CW1815-BBR	63	TIP-CW-2	76
CW1603-BAL	60	CW1815-BR	57	TIP-CW-3	76
CW1603-BBR	60	CW1815-BSA	63	TIP-CW-4	76
CW1603-BR	54	CW1815-SA	57	TIP-CW-9	76
CW1603-BSA	60	CW1816-AL	57	TIP-DEL-10A	46
CW1603-SA	54	CW1816-BAL	63	TIP-DEL-15	46
CW1604-AL	54	CW1816-BBR	63	TIP-DEL-16	46
CW1604-BAL	60	CW1816-BR	57	TIP-DEL-17	46
CW1604-BBR	60	CW1816-BSA	63	TIP-DEL-17B	46
CW1604-BR	54	CW1816-SA	57	TIP-DEL-18	46
CW1604-BSA	60	CW1817-AL	57	TIP-DEL-18H	47
CW1604-SA	54	CW1817-BAL	63	TIP-DEL-18V	47
CW1609-AL	55	CW1817-BBR	63	TIP-DEL-19H	47
CW1609-BAL	61	CW1817-BR	57	TIP-DEL-2	46
CW1609-BBR	61	CW1817-BSA	63	TIP-DEL-20	47
CW1609-BR	55	CW1817-SA	57	TIP-DEL-22	47
CW1609-BSA	61	EZ-1-ESD	1	TIP-DEL-23C	47
CW1609-SA	55	EZ-2-ESD	1	TIP-DEL-24	46
CW1610A-AL	55	MD-1390W-SA	29	TIP-DEL-3	46
CW1610A-BAL	61	MD-1390W-SA-STD	29	TIP-DEL-30A	47
CW1610A-BBR	61	MD-1490W-SA	29	TIP-DEL-4	46
CW1610A-BR	55	MD-5508W-SA	29	TIP-DEL-4B	46
CW1610A-BSA	61	MD-5508W-SA-STD	29	TIP-DEL-50	47
CW1610A-SA	55	MD-5509W-SA	29	TIP-DEL-51	47
CW1615-AL	55	MD-5509W-SA-STD	29	TIP-DEL-52	47
CW1615-BAL	61	MD-5510W-SA	29	TIP-DEL-53	47
CW1615-BBR	61	MD-5510W-SA-STD	29	TIP-DEL-54	47
CW1615-BR	55	MD-5608W-SA	29	TIP-DEL-55	47
CW1615-BSA	61	MD-5609W-SA	29	TIP-DEL-56	47
CW1615-SA	55	MD-5610W-SA	29	TIP-DEL-57	47
CW1616-AL	55	R1300C-SA	5 - 77	TIP-DEL-6	46
CW1616-BAL	61	R1300-SA	5 - 77	TIP-DEL-9	46
CW1616-BBR	61	R1300-SA-EZ	78	TIP-ESD-10A	44
CW1616-BR	55	R1330A-SA	8	TIP-ESD-15	44
CW1616-BSA	61	R1330A-SA-STD	8	TIP-ESD-16	44
CW1616-SA	55	R1430A-SA	8	TIP-ESD-17	44
CW1617-AL	55	R330A-SA	41	TIP-ESD-17B	44
CW1617-BAL	61	R330A-SA-STD	41	TIP-ESD-18	44
CW1617-BBR	61	R430A-SA	41	TIP-ESD-18H	45
CW1617-BR	55	RT5000-SA	78	TIP-ESD-18V	45
CW1617-BSA	61	RT55000-SA	78	TIP-ESD-19H	45
CW1617-SA	55	SC-0	1	TIP-ESD-2	44
CW1802-AL	56	SIPEL-0	1	TIP-ESD-20	45
CW1802-BAL	62	T5000-SA	5 - 78	TIP-ESD-22	45
CW1802-BBR	62	T5508-SA	28	TIP-ESD-23C	45
CW1802-BR	56	T5508-SA-STD	28	TIP-ESD-24	44
CW1802-BSA	62	T5508W-SA	28	TIP-ESD-3	44
CW1802-SA	56	T5508W-SA-STD	28	TIP-ESD-30A	45
CW1803-AL	56	T5509W-SA	28	TIP-ESD-4	44
CW1803-BAL	62	T5509W-SA-STD	28	TIP-ESD-4B	44
CW1803-BBR	62	T5510W-SA	28	TIP-ESD-50	45
CW1803-BR	56	T5510W-SA-STD	28	TIP-ESD-51	45
CW1803-BSA	62	T5531-SA	28	TIP-ESD-52	45
CW1803-SA	56	T5531-SA-STD	28	TIP-ESD-53	45
CW1804-AL	56	T5608-SA	28	TIP-ESD-54	45
CW1804-BAL	62	T5608W-SA	28	TIP-ESD-55	45
CW1804-BBR	62	T5609W-SA	28	TIP-ESD-56	45
CW1804-BR	56	T5610W-SA	28	TIP-ESD-57	45
CW1804-BSA	62	T5631-SA	28	TIP-ESD-6	44
CW1804-SA	56	TIP-1390W	49	TIP-ESD-9	44
CW1809-AL	57	TIP-1390W-STD	48	TIP-STD-10A	48
CW1809-BAL	63	TIP-1490W	50	TIP-STD-15	48
CW1809-BBR	63	TIP-CB-10A	76	TIP-STD-16	48
CW1809-BR	57	TIP-CB-15	76	TIP-STD-17	48
CW1809-BSA	63	TIP-CB-16	76	TIP-STD-17B	48

Part #	Page #	Part #	Page #	Part #	Page #
TIP-STD-18	48				
TIP-STD-18H	48				
TIP-STD-18V	48				
TIP-STD-19H	48				
TIP-STD-2	48				
TIP-STD-20	48				
TIP-STD-22	48				
TIP-STD-23C	48				
TIP-STD-24	48				
TIP-STD-3	48				
TIP-STD-30A	48				
TIP-STD-4	48				
TIP-STD-4B	48				
TIP-STD-50	48				
TIP-STD-51	48				
TIP-STD-52	48				
TIP-STD-53	48				
TIP-STD-54	48				
TIP-STD-55	48				
TIP-STD-56	48				
TIP-STD-57	48				
TIP-STD-6	48				
TIP-STD-9	48				
TIP-T5508	49				
TIP-T5508-STD	48				
TIP-T5508W	49				
TIP-T5508W-STD	48				
TIP-T5509W	49				
TIP-T5509W-STD	48				
TIP-T5510W	49				
TIP-T5510W-STD	48				
TIP-T5531	49				
TIP-T5531-STD	48				
TIP-T5608	50				
TIP-T5608W	50				
TIP-T5609W	50				
TIP-T5610W	50				
TIP-T5631	50				
TS5000-SA	5 - 78				
AP = Adjustable Screw Pressure	1				
C = Short Handle	1				
CERAMIC Quick Change Tweez.	51 to 76				
D = Serrated Tip	1				
QUICK CHANGE Soft Tip Tweez.	6 to 38				
R = Reverse Action	1				
RIVETED Soft Tip Tweez.	39 to 43				
TECHNICAL Info. - CERAMIC	2				
TECHNICAL Info. - GENERAL	1				
TECHNICAL Info. - MATERIALS	3				
TIPS - Black ESD Safe	44-45-49				
TIPS - CERAMIC White & Black	76				
TIPS - STD Grey	48				
TIPS - White DELRIN 500	46-47-50				

	page		page
TECHNICAL INFORMATION		RIVETED SOFT TIP TWEEZERS	
Materials and Options	1	Black ESD Safe	
CERAMIC Quick Change Tweezers	2	White DELRIN 500	
Material's General Characteristics	3	STD Grey Static Dissipative	39 to 42
All Handles	4-5	RED Soft Tip	43
QUICK CHANGE SOFT TIP TWEEZERS		CERAMIC QUICK CHANGE TWEEZERS	
1300-SA, 1300-SA-STD, 1400-SA series	6 to 9	CW1300 series - White	52-53
1300-AL, 1300-AL-STD, 1400-AL series	10-11	CW1600 series - White	54-55
1300-BR, 1300-BR-STD, 1400-BR series	12-13	CW1800 series - White	56-57
1300C-SA, 1300C-SA-STD, 1400C-SA series	26-27		
1600-SA, 1600-SA-STD, 1700-SA series	14-15	CB1300 series - Black	64-65
1600-AL, 1600-AL-STD, 1700-AL series	16-17	CB1600 series - Black	66-67
1600-BR, 1600-BR-STD, 1700-BR series	18-19	CB1800 series - Black	68-69
1800-SA, 1800-SA-STD, 1900-SA series	20-21	CERAMIC QUICK CHANGE TWEEZERS with 45° Bent Handle	
1800-AL, 1800-AL-STD, 1900-AL series	22-23	CW1300-B series - White	58-59
1800-BR, 1800-BR-STD, 1900-BR series	24-25	CW1600-B series - White	60-61
		CW1800-B series - White	62-63
QUICK CHANGE SOFT TIP TWEEZERS with 45° Bent Handle		CB1300-B series - Black	70-71
1300-BSA, 1300-BSA-STD, 1400-BSA series		CB1600-B series - Black	72-73
1300-BAL, 1300-BAL-STD, 1400-BAL series		CB1800-B series - Black	74-75
1300-BBR, 1300-BBR-STD, 1400-BBR series	30 to 32	REPLACEABLE TIPS for Ceramic Quick Change Tweezers	
1600-BSA, 1600-BSA-STD, 1700-BSA series		TIP-CW series - White	
1600-BAL, 1600-BAL-STD, 1700-BAL series		TIP-CB series - Black	76
1600-BBR, 1600-BBR-STD, 1700-BBR series	33 to 35	HANDLES for any series	
1800-BSA, 1800-BSA-STD, 1900-BSA series		77 to 79	
1800-BAL, 1800-BAL-STD, 1900-BAL series		INDEX	
1800-BBR, 1800-BBR-STD, 1900-BBR series	36 to 38	80 to 86	
REPLACEABLE TIPS for Quick Change Soft Tip Tweezers			
Black ESD Safe	44-45		
White DELRIN 500	46-47		
STD Grey Static Dissipative	48		
QUICK CHANGE LEAD STRAIGHTENER and WAFER HANDLING TWEEZERS			
	28-29		
REPLACEABLE TIPS for Quick Change Lead Straightener and Wafer Handling Tweezers			
Black ESD Safe & STD Grey Static Dissipative	49		
White DELRIN 500	50		

