



ESD and CLEANROOM

GARMENTS



OUR COMPANY'S GOAL:

We are dedicated to reach our goal to make our own DLB brand a globally respected and accepted trademark of our high quality ESD products, like other trademarks of the leading manufacturers (American, German, Italian, etc. companies) of the international market.

With our Hungarian product development and production our aim is to provide guidance on ESD product's market and with innovations we want to improve the effectiveness of ESD protection. With this activity, we increase the security of electronics production and prevent the malfunction of electronic products by static discharge and help the safe use of them. With their work our colleagues can contribute to the proper work of lifesaving products: for example to avoid mistakes in production of car braking electronics or to provide the proper operation of medical diagnostic devices.

Our company ensures the livelihood of more than 80 Hungarian families and we strive with our product and market development to continue to increase D és Tsa Team.

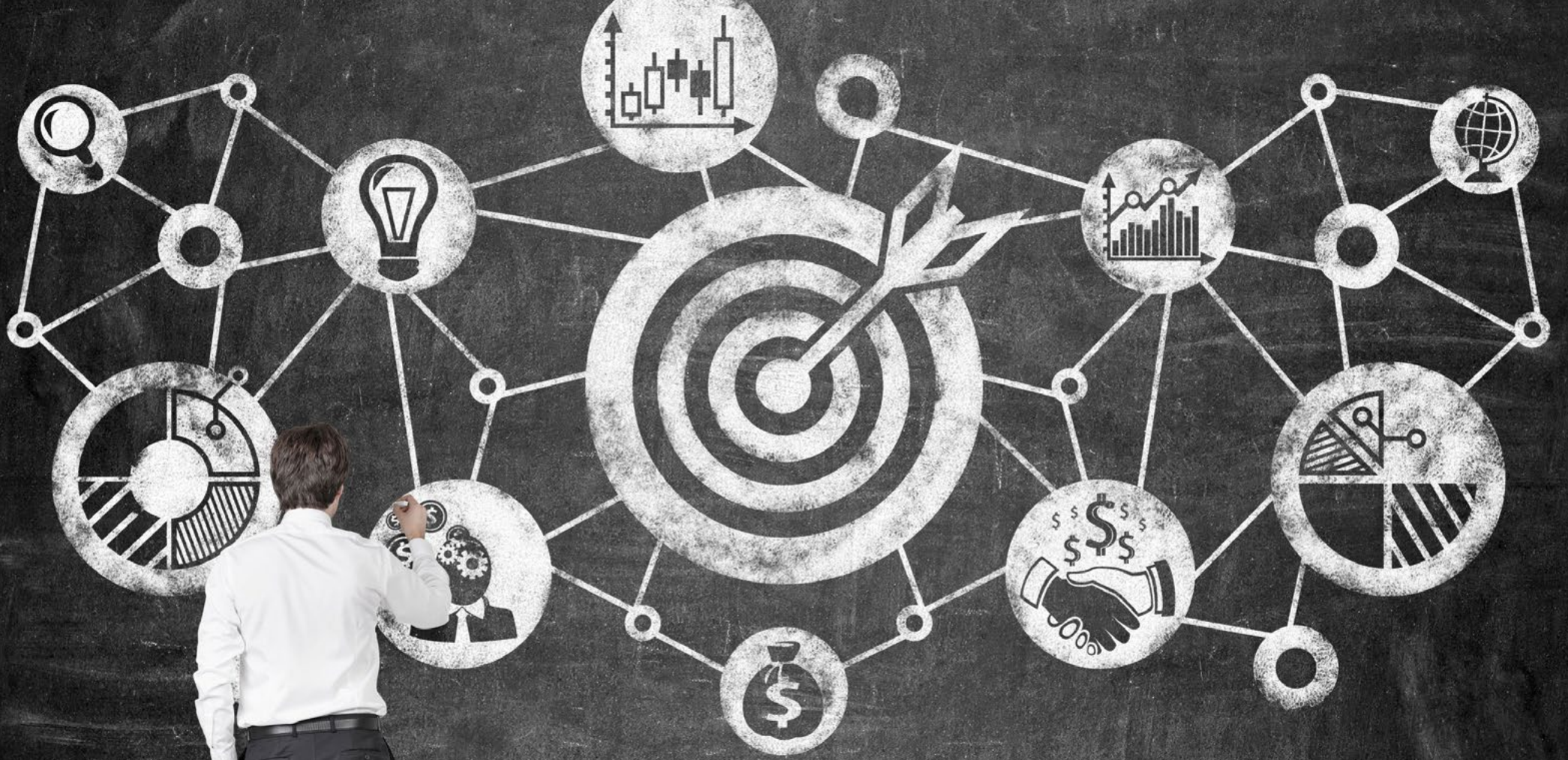



CONTENTS

About our company 6

ESD Requirements8

ESD Fabrics10

Washing instructions and warranty22

STANDARD LINE Collection 24

PREMIUM LINE Collection 42

BUSINESS LINE Collection 50

SUMMER LINE Collection 58

WINTER LINE Collection 74

Other ESD products 100

CLEANROOM LINE Collection102

Size charts, figures 112

LOGO DESIGN 116

Notes 117

* The product and fabric colors shown in the catalogue may differ from the colours of the manufactured products, we do not accept responsibility for any discrepancies. Please request our free fabric sample catalog. This catalog is for informational purposes only, and our company accepts no responsibility for any typographical errors (technical data, sizes, etc.) and reserves the right to make changes.

ABOUT OUR COMPANY

D és Tsa Bt. was established in 1996. It is a 100 % Hungarian owned company. Our main business segment is to provide help in static control - we offer a large scale of products, and different services for ensure well-working ESD protection at companies. These can be helpful for providing security in electronic manufacturing and prevent the damage of electronic products by static discharge. Our business grew gradually through the years. We established our reputation both on domestic and international markets with our quality, self-produced **ESD garments**. You can purchase **ESD entrance systems**, test stations and measurement instruments with our AIJGO brand name. But we can help you with several more items too, for example:

- ✓ Cleanroom garments
- ✓ ESD chairs
- ✓ ESD floor mats and table mats
- ✓ ESD packaging materials
- ✓ ESD personal grounding equipments
- ✓ ESD and safety shoes
- ✓ Soldering stations
- ✓ Soldering materials
- ✓ Hand tools

In the partner network of D és Tsa Bt. there are leading multinational electronics manufacturing corporations, which look on our company as their strategic supplier partner on ESD issues. Our outstanding results could be thank to our highly professional readiness, flexibility and the high quality standards of our sales and production. D és Tsa Bt. is a certified company on the basis of EN ISO 9001:2015 quality management system.

We offer different ESD services which prove our professionalism and made our position on the market even stronger:

- ✓ ESD training
- ✓ ESD audit
- ✓ Real-time ESD event investigation
- ✓ Project support (design, implementation, maintenance)
- ✓ ESD process and related documentation review
- ✓ EPA on-site instrumental inspections / reviews (ESD compliance testing of machinery, floor, production area, production line compliance measurement)
- ✓ Periodic compliance measurements (quarterly, semi-annual)
- ✓ ESD measuring instrument training

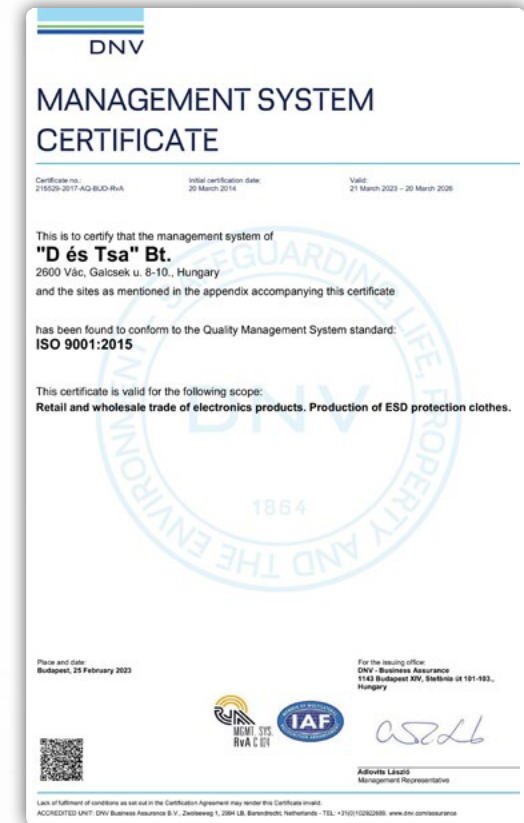



Our company offers good quality, self-produced ESD clothing products for Hungarian and foreign partners, which are manufactured in accordance with the current international ESD standards. Compliance with the standards is also indicated by a label with the same or similar graphics as the image above. If you have a specific need for ESD clothing, you can ask for our help - we can make even one piece if you need it.

YOU DREAM IT - WE MAKE IT.

The quality of our products and the reliability of our company have been successfully able to hold the international markets, which resulting in that most of our production capacity is reserved for export sales.

Based on the feedbacks received from our partners, our slogan has become the following sentence:

”D ÉS TSA BT. OFFERS NOT ONLY PRODUCT BUT COOPERATION AS WELL.”

We hope our products and services can greatly assist your work in the present and in the future.



Balázs Dulay
Owner and Strategic director

ESD REQUIREMENTS

ACCORDING TO IEC 61340-4-9:2024

Common industry description/Use of garment system:	Garment type:	Test procedure:	Specific resistance values:
Garments with some electrical field suppression properties	Static control garment	Resistance point to point	$< 1,0 \times 10^{11} \Omega$
Garments with a designated groundable point	Groundable static control garment	Resistance point to point and resistance point to groundable point	$< 1,0 \times 10^9 \Omega$
Garment in continuous electrical path with a person; however, not the primary ground path	Groundable static control garment	Resistance point to point and resistance point to groundable point	$< 1,0 \times 10^9 \Omega$
Grounded with dual paths to ground via continuous monitoring equipment that requires two separate paths to ground	Groundable static control garment system (garment in combination with person)	Resistance point to point and resistance point to groundable point	$< 1,0 \times 10^9 \Omega$
		Integrated wrist strap in accordance with IEC 61340-4-6:2016	$< 3,5 \times 10^7 \Omega$
Grounded through a single wire constant monitor system	Groundable static control garment system (garment in combination with person)	Resistance point to point and resistance point to groundable point	$< 1,0 \times 10^9 \Omega$
		Integrated wrist strap in accordance with IEC 61340-4-6:2016	$< 3,5 \times 10^7 \Omega$
Garment used as primary grounding path for personnel	Groundable static control garment system (garment in combination with person)	Resistance point to point and resistance point to groundable point	$< 1,0 \times 10^9 \Omega$
		Integrated wrist strap in accordance with IEC 61340-4-6:2016	$< 3,5 \times 10^7 \Omega$

Our ESD clothing meets the above requirements.
 For groundable ESD protective clothing, please use the additional order codes: **GND** (see the images on the right: wrist strap + conductive strip + snap button on the pocket) or **GNDR** (conductive elasticated cuff + conductive strip + snap button on the pocket).



OEKO-TEX® STANDARD 100 CERTIFICATE – to prove that products are harmless for human health

For many of our products, models with OEKO-TEX® STANDARD 100 certification are also available.

"Oeko-Tex® Standard 100 is one of the world's best-known labels for textiles tested for harmful substances."

"If a textile article carries the STANDARD 100 label, you can be certain that every component of this article, i.e. every thread, button and other accessories, has been tested for harmful substances and that the article therefore is harmless for human health."

The test is conducted by independent OEKO-TEX® partner institutes on the basis of an extensive OEKO-TEX® criteria catalog. "In the test they take into account numerous regulated and non-regulated substances, which may be harmful to human health. In many cases the limit values for the STANDARD 100 go beyond national and international requirements."











Source: <https://www.oeko-tex.com/en/our-standards/oeko-tex-standard-100>















ESD FABRICS

ESD WOVEN FABRICS

Type	KK01	TH55	 EECO01	CT35	TH65	MC24	CR10	CR10HI	WC10
Material	Woven	Woven	Woven	Woven	Woven	Woven	Woven (cleanroom)	Woven (cleanroom)	Woven (water repellent)
Polyester (%)	74	63	63	69	36	66	98	98	98
Cotton (%)	24	33	33	27	60	32	-	-	-
Conductive fibre (%)	2	4	4	4	4	2	2	2	2
Lycra (%)	-	-	-	-	-	-	-	-	-
Weight (g/m ²)	125	155	150	130	160	240	115	115	115
Color									
Page	13		14		15		16		17

The color shades of our fabric products may vary from shipment to shipment.

ESD KNITTED FABRICS

Type	TS15	 EECO-TS15	TS16	PS21	 EECO-PS21	LY20	THSS	THSB	FL1
Material	Knitted	Knitted	Knitted (Pique)	Knitted	Knitted	Knitted	Knitted	Knitted (Fluffy)	Fleece
Polyester (%)	-	-	-	47	48	-	48	48	96
Cotton (%)	96	96	96	50	48	88	48	48	-
Conductive fibre (%)	4	4	4	3	4	4	4	4	4
Lycra (%)	-	-	-	-	-	8	-	-	-
Weight (g/m ²)	150	160	210	210	215	200	280	320	280
Color									
Page	17	18		19		20		21	

The color shades of our fabric products may vary from shipment to shipment.

KK01 FABRIC

FEATURES

- > Static dissipative woven fabric (carbon loaded yarns in 5 mm grid)
- > **Composition:** 74% Polyester, 24% Cotton, 2% Conductive fibre
- > **Fabric weight:** 125 g/m²
- > **Finish:** Crease resists, workwear
- > **Resistance from point to point (Rp):** 10⁶ - 10⁷ Ohm
- > **Charging time:** < 2 seconds
- > Complies with IEC 61340-4-9:2024 and ANSI/ESD STM2.1:2018, and keeps this compliance after more than 50 industrial washings
- > Developed for industrial washing

 Machine washable up to 40 °C
 Ironing at maximum 110 °C
 Do not use acid or alkali!
 Drum drying with gentle programme (low temperature, maximum 50°C)
 Do not bleach!



Detailed washing instructions and warranty conditions on page 22



STANDARD COLORS

Black (BK), Dark Green (DZ), Dark Grey (DG), Grey (GA), Light Grey (LG), White (W), Navy Blue (NB), Royal Blue (RB), Light Blue (LB), Mint Green (MG), Light Green (LE), Burgundy (B), Red (R), Orange (O), Yellow (Y), Light Pink (LPK)

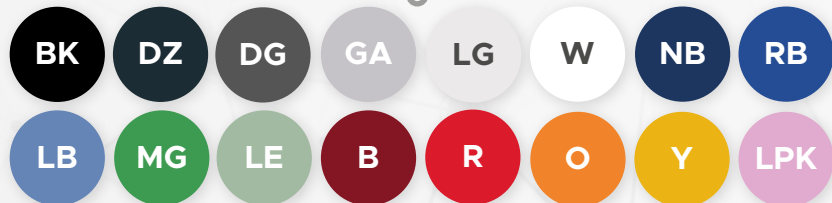

The color shades of our fabric products may vary from shipment to shipment.

 The availability of products manufactured from the colors shown may vary. For current expected delivery times and other requested colors please contact us.

TH55 FABRIC

FEATURES

- > Static dissipative woven fabric (carbon loaded yarns in 5 mm grid)
- > **Composition:** 63% Polyester 33% Cotton 4% Conductive fibre
- > **Fabric weight:** 155 g/m²
- > **Finish:** Crease resists, workwear
- > **Resistance from point to point (Rp):** 10⁶ - 10⁷ Ohm
- > **Charging time:** < 2 seconds
- > Complies with IEC 61340-4-9:2024 and ANSI/ESD STM2.1:2018, and keeps this compliance after more than 50 industrial washings
- > Developed for industrial washing

 Machine washable up to 40 °C
 Ironing at maximum 110 °C
 Do not use acid or alkali!
 Drum drying with gentle programme (low temperature, maximum 50°C)
 Do not bleach!



Detailed washing instructions and warranty conditions on page 22



STANDARD COLORS

Royal Blue (RB), Light Blue (LB), Grey (GA), White (W)



The color shades of our fabric products may vary from shipment to shipment.

 The availability of products manufactured from the colors shown may vary. For current expected delivery times and other requested colors please contact us.

eco EECO01 FABRIC

FEATURES

- > Static dissipative woven fabric (carbon loaded yarns in 4 mm grid)
- > **Composition:** 63% Polyester 33% Cotton 4% Conductive fibre
- > **Fabric weight:** 150 g/m²
- > **Finish:** Crease resists, workwear
- > **Resistance from point to point (Rp):** 10⁶ - 10⁹ Ohm
- > **Charging time:** < 2 seconds
- > Complies with IEC 61340-4-9:2024 and ANSI/ESD STM2.1:2018, and keeps this compliance after more than 50 industrial washings
- > Developed for industrial washing

! Machine washable up to 40 °C
 Ironing at maximum 110 °C
 Do not use acid or alkali!
 Drum drying with gentle programme (low temperature, maximum 50°C)
 Do not bleach!



Detailed washing instructions and warranty conditions on page 22



STANDARD COLORS

Royal Blue (RB), Light Blue (LB), White (W)



The color shades of our fabric products may vary from shipment to shipment.

i The availability of products manufactured from the colors shown may vary. For current expected delivery times and other requested colors please contact us.

CT35 FABRIC

FEATURES

- > Static dissipative woven fabric (carbon loaded yarns in 5 mm grid)
- > **Composition:** 69% Polyester 27% Cotton 4% Conductive fibre
- > **Fabric weight:** 130 g/m²
- > **Finish:** Crease resists, workwear
- > **Resistance from point to point (Rp):** 10⁶ - 10⁷ Ohm
- > **Charging time:** < 2 seconds
- > Complies with IEC 61340-4-9:2024 and ANSI/ESD STM2.1:2018, and keeps this compliance after more than 100 industrial washings
- > Developed for industrial washing

! Machine washable up to 40 °C
 Ironing at maximum 110 °C
 Do not use acid or alkali!
 Drum drying with gentle programme (low temperature, maximum 50°C)
 Do not bleach!



Detailed washing instructions and warranty conditions on page 22



STANDARD COLOR

White (W)



The color shades of our fabric products may vary from shipment to shipment.

i The availability of products manufactured from the color shown may vary. For current expected delivery times and other requested colors please contact us.

TH65 FABRIC

FEATURES

- > Static dissipative woven fabric (carbon loaded yarns in 5 mm grid)
- > **Composition:** 36% Polyester 60% Cotton 4% Conductive fibre
- > **Fabric weight:** 160 g/m²
- > **Finish:** Crease resists, workwear
- > **Resistance from point to point (Rp):** 10⁶ - 10⁷ Ohm
- > **Charging time:** < 2 seconds
- > Complies with IEC 61340-4-9:2024 and ANSI/ESD STM2.1:2018, and keeps this compliance after more than 50 industrial washings
- > Developed for industrial washing

Machine washable up to 40 °C
 Ironing at maximum 110 °C
 Do not use acid or alkali!
 Drum drying with gentle programme (low temperature, maximum 50°C)
 Do not bleach!



Detailed washing instructions and warranty conditions on page 22



STANDARD COLOR

White (**W**)

W

The color shades of our fabric products may vary from shipment to shipment.

 The availability of products manufactured from the color shown may vary. For current expected delivery times and other requested colors please contact us.

MC24 FABRIC

FEATURES

- > Static dissipative woven fabric
- > **Composition:** 66% Polyester, 32% Cotton, 2% Conductive fibre
- > **Fabric weight:** 240 g/m²
- > **Finish:** Workwear
- > **Resistance from point to point (Rp):** 10⁷ - 10¹¹ Ohm
- > **Charging time:** < 2 seconds
- > Complies with IEC 61340-4-9:2024 and ANSI/ESD STM2.1:2018, and keeps this compliance after more than 50 industrial washings
- > Developed for industrial washing

Machine washable up to 40 °C
 Ironing at maximum 110 °C
 Do not use acid or alkali!
 Drum drying with gentle programme (low temperature, maximum 50°C)
 Do not bleach!



Detailed washing instructions and warranty conditions on page 22



STANDARD COLOR

Dark Grey (**DG**)

DG

The color shades of our fabric products may vary from shipment to shipment.

 The availability of products manufactured from the color shown may vary. For current expected delivery times and other requested colors please contact us.

CR10 FABRIC

FEATURES

- › Static dissipative woven fabric (carbon loaded yarns in 5 mm grid)
- › Cleanroom fabric class 10000, ISO 7
- › **Composition:** 98% Polyester 2% Conductive fibre
- › **Fabric weight:** 115 g/m²
- › **Finish:** Crease resists, workwear
- › **Resistance from point to point (Rp):** 10⁶ - 10⁷ Ohm
- › **Charging time:** < 2 seconds
- › Complies with IEC 61340-4-9:2024 and ANSI/ESD STM2.1:2018, and keeps this compliance after more than 50 industrial washings
- › Developed for industrial washing

! Machine washable up to 40 °C
 Ironing at maximum 110 °C
 Do not use acid or alkali!
 Drum drying with gentle programme (low temperature, maximum 50 °C)
 Do not bleach!

 Detailed washing instructions and warranty conditions on page 22



STANDARD COLORS

Light Blue (LB), White (W)



The color shades of our fabric products may vary from shipment to shipment.

i The availability of products manufactured from the colors shown may vary. For current expected delivery times and other requested colors please contact us.

CR10HI FABRIC

FEATURES

- › Static dissipative woven fabric (carbon loaded yarns in 5 mm grid)
- › Cleanroom fabric class 10000, ISO 7
- › **High Visibility fabric**
- › **Composition:** 98% Polyester 2% Conductive fibre
- › **Fabric weight:** 115 g/m²
- › **Finish:** Crease resists, workwear
- › **Resistance from point to point (Rp):** 10⁶ - 10⁷ Ohm
- › **Charging time:** < 2 seconds
- › Complies with IEC 61340-4-9:2024 and ANSI/ESD STM2.1:2018, and keeps this compliance after more than 50 industrial washings
- › Developed for industrial washing

! Machine washable up to 40 °C
 Ironing at maximum 110 °C
 Do not use acid or alkali!
 Drum drying with gentle programme (low temperature, maximum 50 °C)
 Do not bleach!

 Detailed washing instructions and warranty conditions on page 22



STANDARD COLORS

Orange (O), Yellow (Y)



The color shades of our fabric products may vary from shipment to shipment.

i The availability of products manufactured from the colors shown may vary. For current expected delivery times and other requested colors please contact us.

WC10 FABRIC

FEATURES

- > Static dissipative woven fabric (carbon loaded yarns in 5 mm grid)
- > Water repellent material, for outdoor use
- > Cleanroom fabric class 10000, ISO 7
- > **Composition:** 98% Polyester 2% Conductive fibre
- > **Fabric weight:** 115 g/m²
- > **Finish:** Crease resists, workwear
- > **Resistance from point to point (Rp):** 10⁶ - 10⁷ Ohm
- > **Charging time:** < 2 seconds
- > Complies with IEC 61340-4-9:2024 and ANSI/ESD STM2.1:2018, and keeps this compliance after more than 50 industrial washings
- > Developed for industrial washing

 Machine washable up to 40 °C
 Ironing at maximum 110 °C
 Do not use acid or alkali!
 Drum drying with gentle programme (low temperature, maximum 50°C)
 Do not bleach!



Detailed washing instructions and warranty conditions on page 22



STANDARD COLOR

Navy Blue (**NB**)



The color shades of our fabric products may vary from shipment to shipment.

 The availability of products manufactured from the color shown may vary. For current expected delivery times and other requested colors please contact us.

TS15 FABRIC

FEATURES

- > Static dissipative knitted fabric (with carbon yarn)
- > **Composition:** 96% Cotton 4% Conductive fibre
- > **Fabric weight:** 150 g/m²
- > **Finish:** Crease resist, workwear
- > **Resistance from point to point (Rp):** 10⁶ - 10⁷ Ohm
- > **Charging time:** < 2 seconds
- > Complies with IEC 61340-4-9:2024 and ANSI/ESD STM2.1:2018, and keeps this compliance after more than 40 industrial washings
- > Developed for industrial washing

 Machine washable up to 40 °C
 Ironing at maximum 110 °C
 Do not use acid or alkali!
 Tumble drying is prohibited
 Do not bleach!



Detailed washing instructions and warranty conditions on page 22



STANDARD COLORS

Black (**BK**), Navy Blue (**NB**), Royal Blue (**RB**), Dark Grey (**DG**), Grey (**GA**), Burgundy (**B**), Orange (**O**), Dark Green (**GR**), White (**W**)



The color shades of our fabric products may vary from shipment to shipment.

 The availability of products manufactured from the colors shown may vary. For current expected delivery times and other requested colors please contact us.

EECO-TS15 FABRIC

FEATURES

- Static dissipative knitted fabric (with carbon yarn)
- **Composition:** 96% Cotton 4% Conductive fibre
- **Fabric weight:** 160 g/m²
- **Finish:** Crease resists, workwear
- **Resistance from point to point (Rp):** < 10⁹ Ohm
- **Charging time:** < 2 seconds
- Complies with IEC 61340-4-9:2024 and ANSI/ESD STM2.1:2018, and keeps this compliance after more than 40 industrial washings
- Developed for industrial washing

Machine washable up to 40 °C
 Ironing at maximum 110 °C
 Do not use acid or alkali!
 Tumble drying is prohibited
 Do not bleach!



Detailed washing instructions and warranty conditions on page 22



STANDARD COLORS

Dark Green (**DZ**), Turquoise (**T**), black (**BK**), Navy Blue (**NB**), Royal Blue (**RB**), Grey (**GA**), White (**W**)



The color shades of our fabric products may vary from shipment to shipment.

i The availability of products manufactured from the colors shown may vary. For current expected delivery times and other requested colors please contact us.

TS16 FABRIC

FEATURES

- Static dissipative knitted **PIQUE** fabric (with carbon yarn)
- **Composition:** 96% Cotton 4% Conductive fibre
- **Fabric weight:** 210 g/m²
- **Finish:** Crease resists, workwear
- **Resistance from point to point (Rp):** 10⁶ - 10⁷ Ohm
- **Charging time:** < 2 seconds
- Complies with IEC 61340-4-9:2024 and ANSI/ESD STM2.1:2018, and keeps this compliance after more than 40 industrial washings
- Developed for industrial washing

Machine washable up to 40 °C
 Ironing at maximum 110 °C
 Do not use acid or alkali!
 Tumble drying is prohibited
 Do not bleach!



Detailed washing instructions and warranty conditions on page 22



STANDARD COLORS

Black (**BK**), Navy Blue (**NB**), White (**W**)



The color shades of our fabric products may vary from shipment to shipment.

i The availability of products manufactured from the colors shown may vary. For current expected delivery times and other requested colors please contact us.

PS21 FABRIC

FEATURES

- Static dissipative knitted fabric (with carbon yarn)
- **Composition:** 50% Cotton 47% Polyester 3% Conductive fibre
- **Fabric weight:** 210 g/m²
- **Finish:** Crease resists, workwear
- **Resistance from point to point (Rp):** 10⁶ - 10⁷ Ohm
- **Charging time:** < 2 seconds
- Complies with IEC 61340-4-9:2024 and ANSI/ESD STM2.1:2018, and keeps this compliance after more than 40 industrial washings
- Developed for industrial washing



! Machine washable up to 40 °C
 Ironing at maximum 110 °C
 Do not use acid or alkali!
 Tumble drying is prohibited
 Do not bleach!

Detailed washing instructions and warranty conditions on page 22



STANDARD COLORS

Black (**BK**), Navy blue (**NB**), Royal Blue (**RB**), Purple (**PR**), Dark Grey (**DG**), Grey (**GA**), White (**W**),



The color shades of our fabric products may vary from shipment to shipment.

i The availability of products manufactured from the colors shown may vary. For current expected delivery times and other requested colors please contact us.

EECO-PS21 FABRIC

FEATURES

- Static dissipative knitted fabric (with carbon yarn)
- **Composition:** 48% Cotton 48% Polyester 4% Conductive fibre
- **Fabric weight:** 215 g/m²
- **Finish:** Crease resists, workwear
- **Resistance from point to point (Rp):** < 10⁹ Ohm
- **Charging time:** < 2 seconds
- Complies with IEC 61340-4-9:2024 and ANSI/ESD STM2.1:2018, and keeps this compliance after more than 40 industrial washings
- Developed for industrial washing



! Machine washable up to 40 °C
 Ironing at maximum 110 °C
 Do not use acid or alkali!
 Tumble drying is prohibited
 Do not bleach!

Detailed washing instructions and warranty conditions on page 22



STANDARD COLORS

Black (**BK**), Navy blue (**NB**), Royal Blue (**RB**), Purple (**PR**)



The color shades of our fabric products may vary from shipment to shipment.

i The availability of products manufactured from the colors shown may vary. For current expected delivery times and other requested colors please contact us.

LY20 FABRIC

FEATURES

- > Static dissipative knitted fabric (with carbon yarn)
- > **Composition:** 88% Cotton 8% Lycra 4% Conductive fibre
- > **Fabric weight:** 200 g/m²
- > **Finish:** Crease resists, workwear
- > **Resistance from point to point (Rp):** 10⁶ - 10⁷ Ohm
- > **Charging time:** < 2 seconds
- > Complies with IEC 61340-4-9:2024 and ANSI/ESD STM2.1:2018, and keeps this compliance after more than 40 industrial washings
- > Developed for industrial washing

 Machine washable up to 40 °C
 Ironing at maximum 110 °C
 Do not use acid or alkali!
 Tumble drying is prohibited
 Do not bleach!

Detailed washing instructions and warranty conditions on page 22



STANDARD COLOR

Black (BK)



The color shades of our fabric products may vary from shipment to shipment.

i The availability of products manufactured from the color shown may vary. For current expected delivery times and other requested colors please contact us.

THSS FABRIC

FEATURES

- > Static dissipative knitted fabric (with carbon yarn)
- > **Composition:** 48% Polyester 48% Cotton 4% Conductive fibre
- > **Fabric weight:** 280 g/m²
- > **Finish:** Crease resists, workwear
- > **Resistance from point to point (Rp):** 10⁶ - 10⁷ Ohm
- > **Charging time:** < 2 seconds
- > Complies with IEC 61340-4-9:2024 and ANSI/ESD STM2.1:2018, and keeps this compliance after more than 40 industrial washings
- > Developed for industrial washing

 Machine washable up to 40 °C
 Ironing at maximum 110 °C
 Do not use acid or alkali!
 Tumble drying is prohibited
 Do not bleach!

Detailed washing instructions and warranty conditions on page 22



STANDARD COLORS

Black (BK), Navy blue (NB), Royal blue (RB), Yellow (Y), Grey (GA), White (W)



The color shades of our fabric products may vary from shipment to shipment.

i The availability of products manufactured from the colors shown may vary. For current expected delivery times and other requested colors please contact us.

THSB FABRIC

FEATURES

- > Static dissipative knitted fabric (with carbon yarn)
- > Fluffy inner side
- > **Composition:** 48% Polyester 48% Cotton 4% Conductive fibre
- > **Fabric weight:** 320 g/m²
- > **Finish:** Crease resists, workwear
- > **Resistance from point to point (Rp):** 10⁶ - 10⁷ Ohm
- > **Charging time:** < 2 seconds
- > Complies with IEC 61340-4-9:2024 and ANSI/ESD STM2.1:2018, and keeps this compliance after more than 40 industrial washings
- > Developed for industrial washing

! Machine washable up to 40 °C
Ironing at maximum 110 °C
Do not use acid or alkali!
Tumble drying is prohibited
Do not bleach!



Detailed washing instructions and warranty conditions on page 22



STANDARD COLORS

Black (BK), Royal blue (RB)



The color shades of our fabric products may vary from shipment to shipment.

i The availability of products manufactured from the colors shown may vary. For current expected delivery times and other requested colors please contact us.

FL1 FABRIC

FEATURES

- > Static dissipative knitted fabric (with carbon yarn)
- > **Composition:** 96% Polyester 4% Conductive fibre
- > **Fabric weight:** 280 g/m²
- > **Finish:** Fleece
- > **Resistance from point to point (Rp):** 10⁹ - 10¹¹ Ohm
- > **Charging time:** < 2 seconds
- > Complies with IEC 61340-4-9:2024 and ANSI/ESD STM2.1:2018, and keeps this compliance after more than 40 industrial washings
- > Developed for industrial washing

! Machine washable up to 40 °C
Ironing at maximum 110 °C
Do not use acid or alkali!
Tumble drying is prohibited
Do not bleach!



Detailed washing instructions and warranty conditions on page 23



STANDARD COLORS

Black (BK), Navy blue (NB), Dark grey (DG), Orange (O), Yellow (Y)



The color shades of our fabric products may vary from shipment to shipment.

i The availability of products manufactured from the colors shown may vary. For current expected delivery times and other requested colors please contact us.

○ WASHING INSTRUCTIONS

Conductive carbon fibres used in ESD fabrics are very sensitive to high temperatures, alkalis, acids, rinses (softeners) and bleaches. Inadequate use may cause damage to carbon fibres and ESD clothing may lose or significantly deteriorate ESD parameters. Therefore, wash ESD clothing very carefully, in each case please follow the instructions:

KK01, TH55, EECO01, CT35, TH65, MC24, CR10, CR10HI, WC10 FABRICS

- i** In order to preserve the long life of ESD clothings, please use industrial laundries who can provide controlled, documented washing procedures and environment
- i** Wash in cold or not warmer than 40 °C (104 °F) lukewarm water with neutral liquid detergent
- i** Do not use detergents and / or rinse aids that contain bleach and / or chlorine
- i** Bleachers are forbidden
- i** Do not use rinse aids or detergents with a high alkali or high acid content
- i** Do not dry clean
- i** Dry in the open air and / or with drum drying with gentle programme (low temperature, maximum 50 °C (120 °F))
- i** Does not require ironing, but if absolutely necessary, iron at a maximum temperature of 110 °C (230 °F) without steaming
- i** Wash all items inside out
- i** Using deodorant can damage the color of the product
- i** When drying clothes outdoors, do not expose them to direct sunlight
- i** Tighten the zippers before each wash



TS15, EECO-TS15, TS16, PS21, EECO-PS21, LY20, THSS, THSB FABRICS

- i** In the case of knitted fabrics we suggest to determine personal size with measurement on washed clothes. The sizes given by us in size charts meant values before washing regarding products made from these fabrics.
- i** We recommend, in order to preserve the conductivity of the garment in the long term, to entrust washing and drying processes to an industrial laundry where they can provide the necessary technological processes and conditions (documented washing procedures and suitable environment). Adapt the associated cleaning processes to the production technology (e.g. cleanroom requirements) of the product at the place of use.
- i** If the used production technology does not require specific cleaning processes, do washing in cold or lukewarm water at a temperature not warmer than 40 °C (104 °F) with neutral (liquid) detergent.
- i** Ironing of the garment is not necessary or recommended. If the user does iron the garment, iron at a maximum temperature of 110 °C (230 °F) without steaming.
- i** Bleachers are forbidden. Do not use rinse aids or detergents with a high alkali or acid content. Do not use detergents and / or rinse aids that contain bleach and / or chlorine.
- i** Do not use perfumes and deodorants as they may damage the fabric and the color of the product
- i** Do not dry clean. Tumble drying is prohibited.
- i** Wash all garments inside out
- i** Do not expose clothing to direct UV rays. Tighten the zippers before each wash





FL1 FABRIC

- i** In order to preserve the long life of ESD clothings, please use industrial laundries who can provide controlled, documented washing procedures and environment
- i** Wash in cold or not warmer than 40 °C (104 °F) lukewarm water with neutral liquid detergent
- i** Do not use detergents and / or rinse aids that contain bleach and / or chlorine
- i** Bleachers are forbidden
- i** Do not use rinse aids or detergents with a high alkali or high acid content
- i** Do not dry clean
- i** Dry in the open air. Tumble drying is prohibited. After centrifugation, hang dry only
- i** Does not require ironing, but if absolutely necessary, iron at a maximum temperature of 110 °C (230 °F) without steaming
- i** Wash all items inside out
- i** Using deodorant can damage the color of the product
- i** When drying clothes outdoors, do not expose them to direct sunlight
- i** Tighten the zippers before each wash



WARRANTY

- The warranty is strictly valid under controlled and documented industrial laundry conditions, concern the fabric washing cycle as specified in the technical data's.
- The warranty is NOT valid if the washing process is made in home environment!
- The warranty covers ESD parameters and possible sewing errors according to IEC 61340-4-9:2024 and ANSI/ESD STM2.1:2018 standard issued only!
- The warranty does not cover the size and shrinkage differences within the tolerances given at the size charts!
- Our clothing products are provided with the "Operating instructions with symbols" according to the EN ISO 3758:2023 standard.
- If the product shows improper tampering (e.g. tread extension or tearing), the complaint can be rejected.



STANDARD LINE

CLOTHING STYLES



24

ESS ESD SMOCK

1/2 LENGTH



25

EFS ESD SMOCK

1/2 LENGTH



26

ESL ESD SMOCK

2/3 LENGTH



27

EFL ESD SMOCK

2/3 LENGTH



28

ESX ESD SMOCK

1/3 LENGTH



29

EFX ESD SMOCK

1/3 LENGTH



30

**ET ESD MALE
TROUSERS**



31

**ETF ESD FEMALE
TROUSERS**



32

**OT ESD TROUSERS
WITH BRIDLES**



33

OJ ESD JACKET



34

**HIV ESD HIGH
VISIBILITY VEST**



36

KOT ESD TABARD



37

APR ESD APRON



38

**BB ESD
BASEBALL STYLE CAP**



39

**BP ESD
CAP WITH NET**

ESS ESD SMOCK

1/2 LENGTH

FEATURES



- » Standard sizes: Unisex XS - 5XL
- » 2 side pockets, 1 breast pocket with ESD logo
- » Hidden snap-fasteners
- » Cuff with snap-fasteners*

STANDARD FABRICS AND COLORS

KK01 FABRIC					TH55 FABRIC				CT35 FABRIC		TH65 FABRIC	
BK	DZ	DG	GA	LG	RB	LB	GA	W	W	W		
NB	RB	LB	MG	LE	CR10 FABRIC		CR10HI FABRIC		eco EECO01 FABRIC			
B	R	O	Y	LPK	LB	W	O	Y	OEKO TEX	RB	LB	W
W	 You can contact us too for customized embroidered or screen printed company logos, lettering, custom designed ESD clothing.											

OPTIONAL

SHORT SLEEVED VERSION - CODE: SSL

STANDING COLLAR	CONDUCTIVE ELASTICATED CUFF	WAIST KNITTER
		
CODE: AGL	CODE: RAN	CODE: OTO

GROUNDING SMOCK - CODE: GND/GNDR

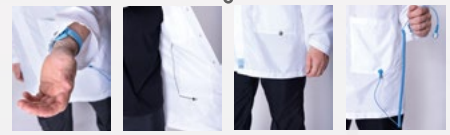

STANDARD 100
25.3.0243
INNOVATEXT

Models with OEKO-TEX® STANDARD 100 certification are also available

eco

Economy - products with economy price

DEMO VIDEO



ORDERING CODE SAMPLE

ESS - **KK01** - **LB** **L** + **DLB** - **RAN** - **W**

style fabric color size option color

DETAILS ON PAGE 113

SIZE CHART (CM)	XS	S	M	L	XL	XXL	3XL	4XL	5XL
Cuff	32	33	34	35	36	36	37	37	38
Sleeve	57	59	63	67	71	71	73	73	74
Length	78	80	82	84	88	90	92	94	96
Chest	90	98	106	114	122	130	136	142	148
Hip	90	98	106	114	122	130	136	142	148
Shoulder	36	39	42	45	48	51	54	57	60

Clothing certified according to the international ESD standards, as indicated by this/similar label



Size tolerance (before washing): 2%

*The picture is with conductive elasticated cuff, which is optional, not standard design

EFS ESD SMOCK

1/2 LENGTH

FEATURES

- » Standard sizes: Female XS - 5XL
- » 2 side pockets, 1 breast pocket with ESD logo
- » Hidden snap-fasteners
- » Cuff with snap-fasteners*

STANDARD FABRICS AND COLORS

KK01 FABRIC **TH55 FABRIC** **CT35 FABRIC** **TH65 FABRIC**

BK DZ DG GA LG RB LB GA W W W

NB RB LB MG LE CR10 FABRIC CR10HI FABRIC EECO01 FABRIC

B R O Y LPK LB W O Y

W

You can contact us too for customized embroidered or screen printed company logos, lettering, custom designed ESD clothing.



ORDERING CODE SAMPLE

EFS - **KK01** - **W L** + DLB - **RAN** - **W**

style fabric color size option color

DETAILS ON PAGE 113

SIZE CHART (CM)	XS	S	M	L	XL	XXL	3XL	4XL	5XL
Cuff	32	33	34	35	36	36	37	37	38
Sleeve	57	59	63	67	71	71	73	73	74
Length	78	80	82	84	88	90	92	94	96
Chest	90	98	106	114	122	130	136	142	148
Hip	90	98	106	114	122	130	136	142	148
Shoulder	36	39	42	45	48	51	54	57	60

Size tolerance (before washing): 2%



Clothing certified according to the international ESD standards, as indicated by this/similar label

DEMO VIDEO



OEKO TEX® STANDARD 100 25.3.0243 INNOVATEX

Models with **OEKO-TEX® STANDARD 100** certification are also available

eco

Economy – products with economy price



*The picture is with conductive elasticated cuff, which is optional, not standard design

ESL ESD SMOCK

2/3 LENGTH

FEATURES

- » Standard sizes: Unisex XS - 5XL
- » 2 side pockets, 1 breast pocket with ESD logo
- » Hidden snap-fasteners
- » Cuff with snap-fasteners

STANDARD FABRICS AND COLORS

KK01 FABRIC					TH55 FABRIC			CT35 FABRIC		TH65 FABRIC	
BK	DZ	DG	GA	LG	RB	LB	GA	W	W	W	
NB	RB	LB	MG	LE	CR10 FABRIC		CR10HI FABRIC		EEOO1 FABRIC		
B	R	O	Y	LPK	LB	W	O	Y	 RB LB W		
W											



DEMO VIDEO



ORDERING CODE SAMPLE

ESL - **KK01** - **W L**
 style fabric color size



You can contact us too for customized embroidered or screen printed company logos, lettering, custom designed ESD clothing.

DETAILS ON PAGE 113

SIZE CHART (CM)	XS	S	M	L	XL	XXL	3XL	4XL	5XL
Cuff	32	33	34	35	36	36	37	37	38
Sleeve	57	59	63	67	71	71	73	73	74
Length	89	91	93	95	99	101	103	105	107
Chest	90	98	106	114	122	130	136	142	148
Hip	90	98	106	114	122	130	136	142	148
Shoulder	36	39	42	45	48	51	54	57	60

Size tolerance (before washing): 2%

Clothing certified according to the international ESD standards, as indicated by this/similar label



EFL ESD SMOCK

2/3 LENGTH

FEATURES

- » Standard sizes: Female XS - 5XL
- » 2 side pockets, 1 breast pocket with ESD logo
- » Hidden snap-fasteners
- » Cuff with snap-fasteners

STANDARD FABRICS AND COLORS

KK01 FABRIC
 BK DZ DG GA LG
 NB RB LB MG LE
 B R O Y LPK
 W

TH55 FABRIC
 RB LB GA W W
 CR10 FABRIC
 LB W

CT35 FABRIC
 W W

TH65 FABRIC
 W

CR10HI FABRIC
 O Y

EECO01 FABRIC
 OEKO-TEX RB LB W

ORDERING CODE SAMPLE

EFL - **TH55** - **LB L**
 style fabric color size

DEMO VIDEO



OEKO-TEX® STANDARD 100
 25.3.0243 INNOVATEX
 Models with OEKO-TEX® STANDARD 100 certification are also available

eco
 Economy – products with economy price

SHORT SLEEVED VERSION - CODE: SSL

STANDING COLLAR CONDUCTIVE ELASTICATED CUFF WAIST KNITTER

CODE: AGL CODE: RAN CODE: OTO

GROUNDING SMOCK - CODE: GND/GNDR

OPTIONAL



You can contact us too for customized embroidered or screen printed company logos, lettering, custom designed ESD clothing.

DETAILS ON PAGE 113

SIZE CHART (CM)	XS	S	M	L	XL	XXL	3XL	4XL	5XL
Cuff	32	33	34	35	36	36	37	37	38
Sleeve	57	59	63	67	71	71	73	73	74
Length	89	91	93	95	99	101	103	105	107
Chest	90	98	106	114	122	130	136	142	148
Hip	90	98	106	114	122	130	136	142	148
Shoulder	36	39	42	45	48	51	54	57	60

Size tolerance (before washing): 2%



Clothing certified according to the international ESD standards, as indicated by this/similar label

ESX ESD SMOCK

1/3 LENGTH

FEATURES



- » Standard sizes: Unisex XS - 5XL
- » 2 side pockets, 1 breast pocket with ESD logo
- » Hidden snap-fasteners
- » Cuff with snap-fasteners

STANDARD FABRICS AND COLORS

KK01 FABRIC					TH55 FABRIC				CT35 FABRIC		TH65 FABRIC	
BK	DZ	DG	GA	LG	RB	LB	GA	W	W	W		
NB	RB	LB	MG	LE	CR10 FABRIC		CR10HI FABRIC		eco EECO01 FABRIC			
B	R	O	Y	LPK	LB	W	O	Y	OEKO TEX RB LB W			
W												

OPTIONAL

SHORT SLEEVED VERSION - CODE: SSL

STANDING COLLAR	CONDUCTIVE ELASTICATED CUFF	WAIST KNITTER
		
CODE: AGL	CODE: RAN	CODE: OTO

GROUNDING SMOCK - CODE: GND/GNDR



OEKO TEX STANDARD 100 25.3.0243 INNOVATEX
Models with OEKO-TEX® STANDARD 100 certification are also available

eco
Economy - products with economy price

DEMO VIDEO



ORDERING CODE SAMPLE

ESX - **TH55** - **RB** **L**
style fabric color size



You can contact us too for customized embroidered or screen printed company logos, lettering, custom designed ESD clothing.

DETAILS ON PAGE 113

Clothing certified according to the international ESD standards, as indicated by this/similar label



SIZE CHART (CM)	XS	S	M	L	XL	XXL	3XL	4XL	5XL
Cuff	32	33	34	35	36	36	37	37	38
Sleeve	57	59	63	67	71	71	73	73	74
Length	58	60	62	64	68	70	72	74	76
Chest	90	98	106	114	122	130	136	142	148
Hip	90	98	106	114	122	130	136	142	148
Shoulder	36	39	42	45	48	51	54	57	60

Size tolerance (before washing): 2%

EFX ESD SMOCK

1/3 LENGTH

FEATURES

- » Standard sizes: Female XS - 5XL
- » 2 side pockets, 1 breast pocket with ESD logo
- » Hidden snap-fasteners
- » Cuff with snap-fasteners*

STANDARD FABRICS AND COLORS

KK01 FABRIC **TH55 FABRIC** **CT35 FABRIC** **TH65 FABRIC**

BK DZ DG GA LG RB LB GA W W W

NB RB LB MG LE **CR10 FABRIC** **CR10HI FABRIC** **eco EECO01 FABRIC**

B R O Y LPK LB W O Y **OEKO TEX®** RB LB W

W

You can contact us too for customized embroidered or screen printed company logos, lettering, custom designed ESD clothing.



ORDERING CODE SAMPLE

EFX - **KK01** - **LE L** + **DLB** - **RAN** - **W**
 style fabric color size option color

DETAILS ON PAGE 113

SIZE CHART (CM)	XS	S	M	L	XL	XXL	3XL	4XL	5XL
Cuff	32	33	34	35	36	36	37	37	38
Sleeve	57	59	63	67	71	71	73	73	74
Length	58	60	62	64	68	70	72	74	76
Chest	90	98	106	114	122	130	136	142	148
Hip	90	98	106	114	122	130	136	142	148
Shoulder	36	39	42	45	48	51	54	57	60

Size tolerance (before washing): 2%



Clothing certified according to the international ESD standards, as indicated by this/similar label

DEMO VIDEO



OEKO TEX® STANDARD 100 25.3.0243 INNOVATEX

Models with **OEKO-TEX® STANDARD 100** certification are also available

eco

Economy – products with economy price



*The picture is with conductive elasticated cuff, which is optional, not standard design

ET ESD MALE TROUSERS



FEATURES

- » Standard sizes: Male XS - 5XL
- » Straight cut
- » 2 side pockets, 2 additional pockets on the legs, 1 hip pocket with ESD logo
- » Rubberized waist with snap-fastener

STANDARD FABRICS AND COLORS

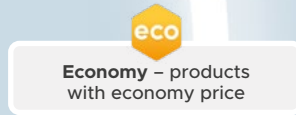

DEMO VIDEO



KK01 FABRIC

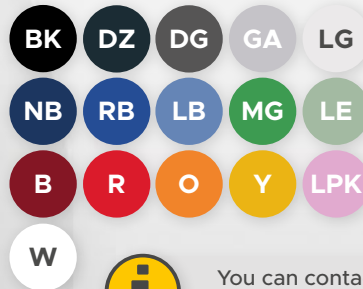

TH55 FABRIC



CT35 FABRIC



TH65 FABRIC



CR10 FABRIC



CR10HI FABRIC



MC24 FABRIC



You can contact us too for customized embroidered or screen printed company logos, lettering, custom designed ESD clothing.

ORDERING CODE SAMPLE

ET - **KK01** - **DG** **L**
 style fabric color size

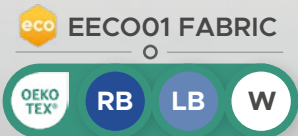

Clothing certified according to the international ESD standards, as indicated by this/similar label



SIZE CHART (CM)	XS	S	M	L	XL	XXL	3XL	4XL	5XL
Length external	102	104	106	108	110	112	114	116	118
Hip	98	102	107	111	115	119	123	128	132

DETAILS ON PAGE 113

Size tolerance (before washing): 2%

ETF ESD FEMALE TROUSERS

FEATURES

- » Standard sizes: Female XS - 5XL
- » Straight cut
- » 2 side pockets, 2 additional pockets on the legs, 1 hip pocket with ESD logo
- » Rubberized waist with snap-fastener

STANDARD FABRICS AND COLORS

KK01 FABRIC					TH55 FABRIC				CT35 FABRIC		TH65 FABRIC	
BK	DZ	DG	GA	LG	RB	LB	GA	W	W	W		
NB	RB	LB	MG	LE	CR10 FABRIC		CR10HI FABRIC		MC24 FABRIC			
B	R	O	Y	LPK	LB	W	O	Y	DG			
W												

You can contact us too for customized embroidered or screen printed company logos, lettering, custom designed ESD clothing.



ORDERING CODE SAMPLE

ETF - KK01 - DG L
 style fabric color size

eco EECO01 FABRIC

OEKO TEX® RB LB W

DEMO VIDEO



OEKO TEX® STANDARD 100 25.3.0243 INNOVATEX

Models with OEKO-TEX® STANDARD 100 certification are also available

eco

Economy – products with economy price



DETAILS ON PAGE 113

SIZE CHART (CM)	XS	S	M	L	XL	XXL	3XL	4XL	5XL
Length external	102	104	106	108	110	112	114	116	118
Hip	84	90	96	102	108	114	120	126	132

Size tolerance (before washing): 2%



Clothing certified according to the international ESD standards, as indicated by this/similar label

OT ESD TROUSERS WITH BRIDLES



FEATURES

- » Standard sizes: Unisex XS - 5XL
- » 2 side pockets, 1 front pocket with ESD logo
- » 2 side pockets on the legs
- » 2 quick release buckles

STANDARD FABRICS AND COLORS

KK01 FABRIC					TH55 FABRIC				CT35 FABRIC		TH65 FABRIC
BK	DZ	DG	GA	LG	RB	LB	GA	W	W		W
NB	RB	LB	MG	LE	CR10 FABRIC		CR10HI FABRIC		MC24 FABRIC		
B	R	O	Y	LPK	LB	W	O	Y		DG	
W	 You can contact us too for customized embroidered or screen printed company logos, lettering, custom designed ESD clothing.										

 Economy – products with economy price

DEMO VIDEO



ORDERING CODE SAMPLE

OT - **KK01** - **RB** **L**
 style fabric color size

 **ECCO01 FABRIC**

RB **LB** **W**

Clothing certified according to the international ESD standards, as indicated by this/similar label



DETAILS ON PAGE 113									
SIZE CHART (CM)	XS	S	M	L	XL	XXL	3XL	4XL	5XL
Length external	102	104	106	108	110	112	114	116	118
Hip	98	102	107	111	115	119	123	128	132

Size tolerance (before washing): 2%

OJ ESD JACKET

FEATURES

- » Standard sizes: Unisex XS - 5XL
- » 2 side pockets, 2 breast pockets
- » ESD logo on chest pocket
- » Hidden zipper
- » Rubberized cuff

STANDARD FABRICS AND COLORS

KK01 FABRIC					TH55 FABRIC					CT35 FABRIC			TH65 FABRIC		
BK	DZ	DG	GA	LG	RB	LB	GA	W	W	W					
NB	RB	LB	MG	LE	CR10 FABRIC			CR10HI FABRIC			MC24 FABRIC				
B	R	O	Y	LPK	LB	W	O	Y	DG						
W															

You can contact us too for customized embroidered or screen printed company logos, lettering, custom designed ESD clothing.



ORDERING CODE SAMPLE

OJ - KK01 - RB L
 style fabric color size

eco EECO01 FABRIC

OEKO TEX RB LB W

OEKO TEX STANDARD 100 25.3.0243 INNOVATEX

Models with OEKO-TEX® STANDARD 100 certification are also available

eco

Economy – products with economy price

DEMO VIDEO



DETAILS ON PAGE 113

SIZE CHART (CM)	XS	S	M	L	XL	XXL	3XL	4XL	5XL
Sleeve	61	63	67	71	75	76	77	77	78
Length	63	65	67	69	71	73	75	76	77
Chest	90	98	106	114	122	130	136	142	148
Shoulder	40	43	46	49	52	55	58	61	65
Shoulder-sleeve circumference	56	58	60	62	64	66	68	70	72

Size tolerance (before washing): 2%



Clothing certified according to the international ESD standards, as indicated by this/similar label

HIV ESD HIGH VISIBILITY VEST



FEATURES

- » Standard sizes: Unisex S-5XL
- » With reflective stripes
- » ESD logo on the chest area
- » Hidden snap-fasteners

STANDARD FABRIC AND COLORS

CR10HI FABRIC



Not an occupational safety product



You can contact us too for customized embroidered or screen printed company logos, lettering, custom designed ESD clothing.



DEMO VIDEO



ORDERING CODE SAMPLE

HIV - **CR10HI** - **O** **L**
 style fabric color size

Clothing certified according to the international ESD standards, as indicated by this/similar label



DETAILS ON PAGE 113

SIZE CHART (CM)	XS	S	M	L	XL	XXL	3XL	4XL	5XL
Chest	111	114	118	122	126	130	134	138	142
Length	61	61	63	65	67	69	71	73	75

Size tolerance (before washing): 2%

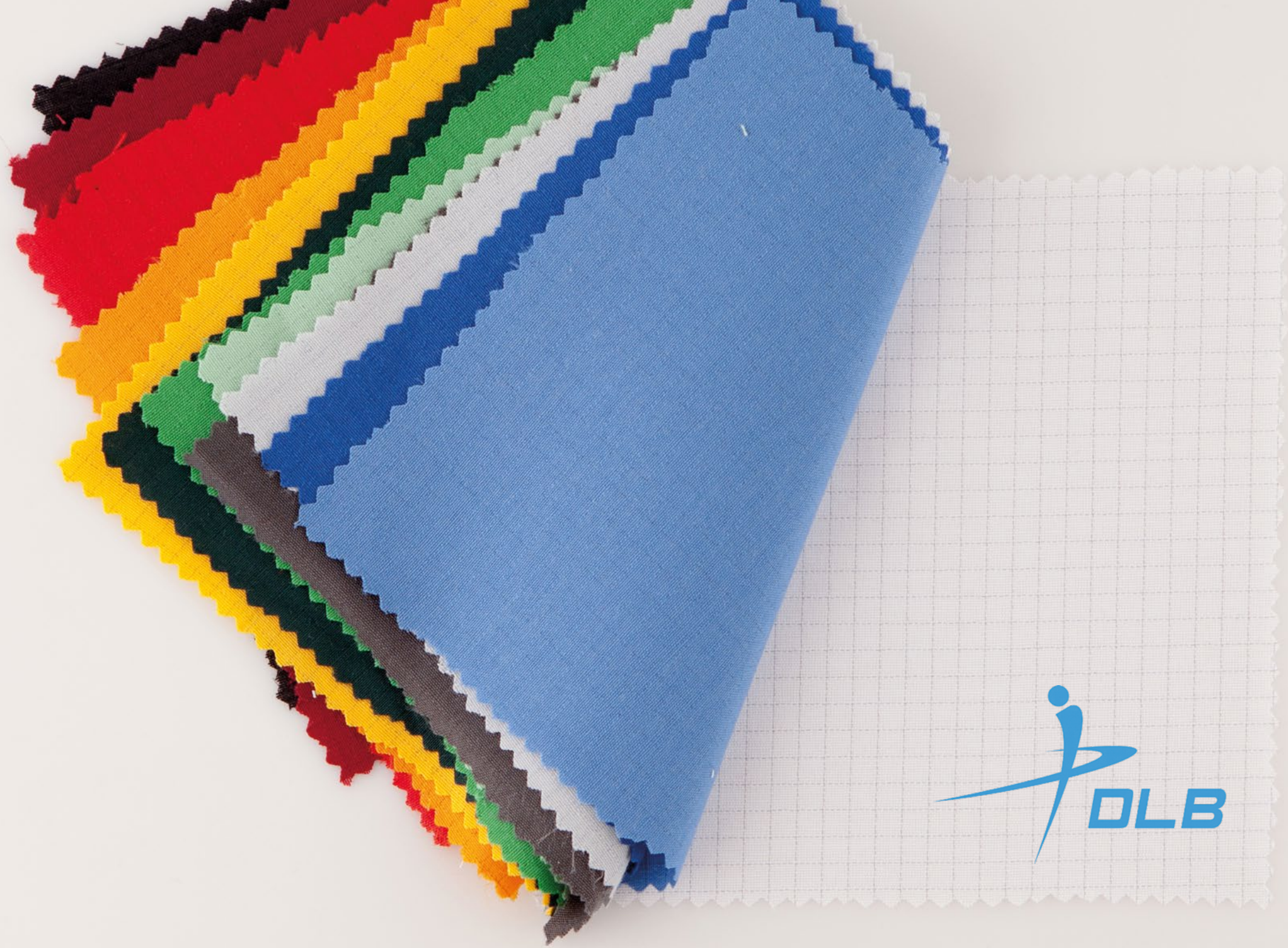

KOT ESD TABARD



FEATURES

- » Standard sizes: XS - 5XL
- » ESD logo on pocket
- » 1 pocket
- » Adjustable side straps with snap fasteners
- » Pullover type

STANDARD FABRICS AND COLORS

KK01 FABRIC					TH55 FABRIC				CT35 FABRIC		TH65 FABRIC	
BK	DZ	DG	GA	LG	RB	LB	GA	W	W		W	
NB	RB	LB	MG	LE	CR10 FABRIC		CR10HI FABRIC		eco EECO01 FABRIC			
B	R	O	Y	LPK	LB	W	O	Y	OEKO TEX	RB	LB	W
W												

OEKO TEX® STANDARD 100 25.3.0243 INNOVATEXT
Models with OEKO-TEX® STANDARD 100 certification are also available

eco
Economy – products with economy price

VIDEO / WEBPAGE



ORDERING CODE SAMPLE

KOT - **KK01** - **BK** **L**
style fabric color size



You can contact us too for customized embroidered or screen printed company logos, lettering, custom designed ESD clothing.

Clothing certified according to the international ESD standards, as indicated by this/similar label



SIZE CHART (CM)	XS	S	M	L	XL	XXL	3XL	4XL	5XL
Length	76	78	80	82	84	86	88	90	92

Size tolerance (before washing): 2%

APR ESD APRON

FEATURES

- » Unisex, one size
- » ESD logo on the chest area

STANDARD FABRICS AND COLORS

KK01 FABRIC					TH55 FABRIC					CT35 FABRIC		TH65 FABRIC	
BK	DZ	DG	GA	LG	RB	LB	GA	W	W	W	W		
NB	RB	LB	MG	LE	CR10 FABRIC		CR10HI FABRIC		eco EECO01 FABRIC				
B	R	O	Y	LPK	LB	W	O	Y	OEKO TEX®	RB	LB	W	
W													

eco
Economy – products with economy price

Models with **OEKO-TEX® STANDARD 100** certification are also available

ORDERING CODE SAMPLE

APR - KK01 - BK
style fabric color

VIDEO / WEBPAGE



You can contact us too for customized embroidered or screen printed company logos, lettering, custom designed ESD clothing.



Clothing certified according to the international ESD standards, as indicated by this/similar label

BB ESD BASEBALL STYLE CAP



FEATURES

- » Unisex, one size
- » Sun visor
- » ESD logo
- » Rubberized back



STANDARD FABRICS AND COLORS

KK01 FABRIC					TH55 FABRIC				CT35 FABRIC		TH65 FABRIC	
BK	DZ	DG	GA	LG	RB	LB	GA	W	W	W		
NB	RB	LB	MG	LE	CR10 FABRIC		CR10HI FABRIC		eco EECO01 FABRIC			
B	R	O	Y	LPK	LB	W	O	Y	OEKO-TEX®	RB	LB	W
W												

ORDERING CODE SAMPLE

BB - **KK01** - **DG**
 style fabric color



You can contact us too for customized embroidered or screen printed company logos, lettering, custom designed ESD clothing.

Clothing certified according to the international ESD standards, as indicated by this/similar label



DEMO VIDEO



BP ESD CAP WITH NET

FEATURES

- » Unisex, one size
- » Breathable net on the top of the cap
- » ESD logo
- » Plastic size adjuster on the back

OEKO TEX® STANDARD 100
25.3.0243 INNOVATEXT

Models with **OEKO-TEX®** STANDARD 100 certification are also available

eco

Economy – products with economy price

STANDARD FABRICS AND COLORS

KK01 FABRIC					TH55 FABRIC					CT35 FABRIC		TH65 FABRIC	
BK	DZ	DG	GA	LG	RB	LB	GA	W	W	W			
NB	RB	LB	MG	LE	CR10 FABRIC		CR10HI FABRIC		eco EECO01 FABRIC				
B	R	O	Y	LPK	LB	W	O	Y	OEKO TEX®	RB	LB	W	
W													

ORDERING CODE SAMPLE

BP - **KK01** - **LPK**
 style fabric color

i

You can contact us too for customized embroidered or screen printed company logos, lettering, custom designed ESD clothing.



DEMO VIDEO



Clothing certified according to the international ESD standards, as indicated by this/similar label



PREMIUM LINE

CLOTHING STYLES



42

PF1 ESD PREMIUM SMOCK

2/3 LENGTH



43

PS1 ESD PREMIUM SMOCK

2/3 LENGTH



44

PF2 ESD PREMIUM SMOCK

2/3 LENGTH



45

PS2 ESD PREMIUM SMOCK

2/3 LENGTH



46

PF3 ESD PREMIUM SMOCK

2/3 LENGTH



47

PS3 ESD PREMIUM SMOCK

2/3 LENGTH

PF1 ESD PREMIUM SMOCK

2/3 LENGTH

FEATURES

- » Standard sizes: Female XS - 5XL
- » 2 side pockets
- » Hidden snap-fasteners
- » Cuff with snap-fasteners
- » ESD logo on the chest area

STANDARD FABRICS AND COLORS

OPTIONAL

GROUNDING SMOCK - CODE: GND/GNDR

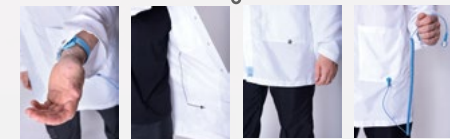

DEMO VIDEO



KK01 FABRIC

BK DZ DG GA LG
 NB RB LB MG LE
 B R O Y LPK
 W

TH55 FABRIC

RB LB GA W

EECO01 FABRIC

OEKO-TEX RB LB W



CHOOSE THE MOST MATCHING COLOUR COMBINATION THAT SUITS YOUR COMPANY



You can contact us too for customized embroidered or screen printed company logos, lettering, custom designed ESD clothing.

ORDERING CODE SAMPLE

PF1 - KK01 - Y - DG L
 style fabric color1 color2 size

DETAILS ON PAGE 113

SIZE CHART (CM)	XS	S	M	L	XL	XXL	3XL	4XL	5XL
Cuff	32	33	34	35	36	36	37	37	38
Sleeve	57	59	63	67	71	71	73	73	74
Length	89	91	93	95	99	101	103	105	107
Chest	90	98	106	114	122	130	136	142	148
Hip	90	98	106	114	122	130	136	142	148
Shoulder	36	39	42	45	48	51	54	57	60

Clothing certified according to the international ESD standards, as indicated by this/similar label



DESIGNED BY *Zsófia Gáspár*

Size tolerance (before washing): 2%

PS1 ESD PREMIUM SMOCK

OPTIONAL

GROUNDING SMOCK - CODE: GND/GNDR

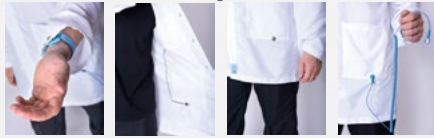

2/3 LENGTH FEATURES

- » Standard sizes: Male XS - 5XL
- » 2 side pockets, 1 hidden breast pocket
- » Hidden snap-fasteners
- » Cuff with snap-fasteners
- » ESD logo on the chest area

STANDARD FABRICS AND COLORS

eco EECO01 FABRIC



TH55 FABRIC



KK01 FABRIC

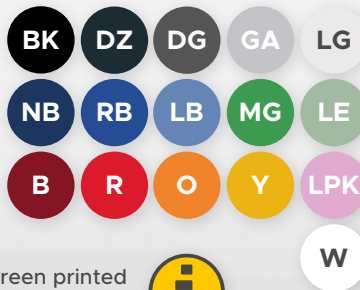

CHOOSE THE MOST MATCHING COLOUR COMBINATION THAT SUITS YOUR COMPANY



You can contact us too for customized embroidered or screen printed company logos, lettering, custom designed ESD clothing.



ORDERING CODE SAMPLE

PS1 - **KK01** - **O** - **RB** **L**
 style fabric color1 color2 size



DEMO VIDEO



DESIGNED BY *Zsófia Gáspár*

DETAILS ON PAGE 113

SIZE CHART (CM)	XS	S	M	L	XL	XXL	3XL	4XL	5XL
Cuff	32	33	34	35	36	36	37	37	38
Sleeve	57	59	63	67	71	71	73	73	74
Length	89	91	93	95	99	101	103	105	107
Chest	90	98	106	114	122	130	136	142	148
Hip	90	98	106	114	122	130	136	142	148
Shoulder	36	39	42	45	48	51	54	57	60

Size tolerance (before washing): 2%



Clothing certified according to the international ESD standards, as indicated by this/similar label

PF2 ESD PREMIUM SMOCK



2/3 LENGTH

FEATURES

- » Standard sizes: Female XS - 5XL
- » 2 side pockets
- » Hidden snap-fasteners
- » Rubberized cuff
- » ESD logo on the chest area

STANDARD FABRICS AND COLORS



DEMO VIDEO



OPTIONAL

GROUNDING SMOCK - CODE: GND/GNDR

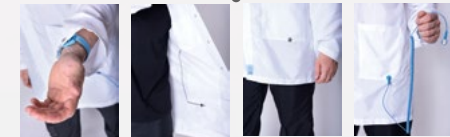

KK01 FABRIC

BK DZ DG GA LG
NB RB LB MG LE
B R O Y LPK
W

TH55 FABRIC

RB LB GA W

eco EECO01 FABRIC

OEKO-TEX RB LB W

CHOOSE THE MOST MATCHING COLOUR COMBINATION THAT SUITS YOUR COMPANY

You can contact us too for customized embroidered or screen printed company logos, lettering, custom designed ESD clothing.

ORDERING CODE SAMPLE

PF2 - **KK01** - **W** - **B** **L**
 style fabric color1 color2 size

DETAILS ON PAGE 113

Clothing certified according to the international ESD standards, as indicated by this/similar label



SIZE CHART (CM)	XS	S	M	L	XL	XXL	3XL	4XL	5XL
Cuff	32	33	34	35	36	36	37	37	38
Sleeve	57	59	63	67	71	71	73	73	74
Length	89	91	93	95	99	101	103	105	107
Chest	90	98	106	114	122	130	136	142	148
Hip	90	98	106	114	122	130	136	142	148
Shoulder	36	39	42	45	48	51	54	57	60

Size tolerance (before washing): 2%

DESIGNED BY *Andrea Vandornyzik*

PS2 ESD PREMIUM SMOCK

2/3 LENGTH

OPTIONAL

GROUNDING SMOCK - CODE: GND/GNDR

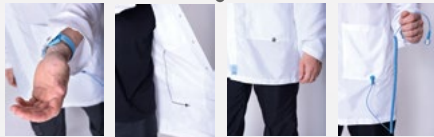

FEATURES

- » Standard sizes: Male XS - 5XL
- » 2 side pockets
- » Hidden snap-fasteners
- » Rubberized cuff
- » ESD logo on the chest area

STANDARD FABRICS AND COLORS

eco EECO01 FABRIC



TH55 FABRIC



KK01 FABRIC

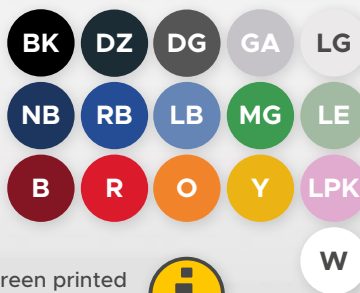

CHOOSE THE MOST MATCHING COLOUR COMBINATION THAT SUITS YOUR COMPANY



You can contact us too for customized embroidered or screen printed company logos, lettering, custom designed ESD clothing.



ORDERING CODE SAMPLE

PS2 - **KK01** - **W** - **DZ** **L**
 style fabric color1 color2 size

STANDARD 100
 25.3.0243
 INNOVATEX
 Models with OEKO-TEX® STANDARD 100 certification are also available

eco
 Economy – products with economy price

DEMO VIDEO



DESIGNED BY *Andrea Vandornyzik*

DETAILS ON PAGE 113

SIZE CHART (CM)	XS	S	M	L	XL	XXL	3XL	4XL	5XL
Cuff	32	33	34	35	36	36	37	37	38
Sleeve	57	59	63	67	71	71	73	73	74
Length	89	91	93	95	99	101	103	105	107
Chest	90	98	106	114	122	130	136	142	148
Hip	90	98	106	114	122	130	136	142	148
Shoulder	36	39	42	45	48	51	54	57	60

Size tolerance (before washing): 2%



Clothing certified according to the international ESD standards, as indicated by this/similar label

PF3 ESD PREMIUM SMOCK

2/3 LENGTH

FEATURES

- » Standard sizes: Female XS - 5XL
- » 2 side pockets
- » Hidden snap-fasteners
- » Cuff with snap-fasteners
- » ESD logo on the chest area

STANDARD FABRICS AND COLORS

OPTIONAL

GROUNDING SMOCK - CODE: GND/GNDR

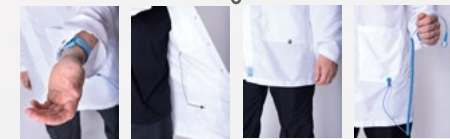

DEMO VIDEO



KK01 FABRIC

BK DZ DG GA LG
NB RB LB MG LE
B R O Y LPK
W

TH55 FABRIC

RB LB GA W

eco EECO01 FABRIC

OEKO-TEX RB LB W

CHOOSE THE MOST MATCHING COLOUR COMBINATION THAT SUITS YOUR COMPANY

i You can contact us too for customized embroidered or screen printed company logos, lettering, custom designed ESD clothing.

ORDERING CODE SAMPLE

PF3 - KK01 - B - Y L
 style fabric color1 color2 size

DETAILS ON PAGE 113

Clothing certified according to the international ESD standards, as indicated by this/similar label



SIZE CHART (CM)	XS	S	M	L	XL	XXL	3XL	4XL	5XL
Cuff	32	33	34	35	36	36	37	37	38
Sleeve	57	59	63	67	71	71	73	73	74
Length	89	91	93	95	99	101	103	105	107
Chest	90	98	106	114	122	130	136	142	148
Hip	90	98	106	114	122	130	136	142	148
Shoulder	36	39	42	45	48	51	54	57	60

Size tolerance (before washing): 2%

DESIGNED BY *Barbala Kovacs*

PS3 ESD PREMIUM SMOCK

2/3 LENGTH

OPTIONAL

GROUNDING SMOCK - CODE: GND/GNDR

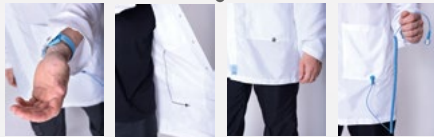

FEATURES

- » Standard sizes: Male XS - 5XL
- » 2 side pockets
- » Hidden snap-fasteners
- » Cuff with snap-fasteners
- » ESD logo on the chest area

STANDARD FABRICS AND COLORS

eco EECO01 FABRIC



TH55 FABRIC



KK01 FABRIC

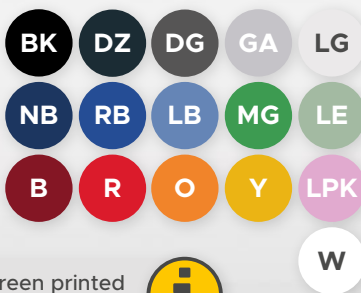

CHOOSE THE MOST MATCHING COLOUR COMBINATION THAT SUITS YOUR COMPANY



You can contact us too for customized embroidered or screen printed company logos, lettering, custom designed ESD clothing.



ORDERING CODE SAMPLE

PS3 - KK01 - NB - MG L
 style fabric color1 color2 size

DETAILS ON PAGE 113

SIZE CHART (CM)	XS	S	M	L	XL	XXL	3XL	4XL	5XL
Cuff	32	33	34	35	36	36	37	37	38
Sleeve	57	59	63	67	71	71	73	73	74
Length	89	91	93	95	99	101	103	105	107
Chest	90	98	106	114	122	130	136	142	148
Hip	90	98	106	114	122	130	136	142	148
Shoulder	36	39	42	45	48	51	54	57	60

Size tolerance (before washing): 2%



Clothing certified according to the international ESD standards, as indicated by this/similar label



Models with OEKO-TEX® STANDARD 100 certification are also available



Economy – products with economy price

DEMO VIDEO



DESIGNED BY *Barbala Kovacs*



BUSINESS LINE

CLOTHING STYLES

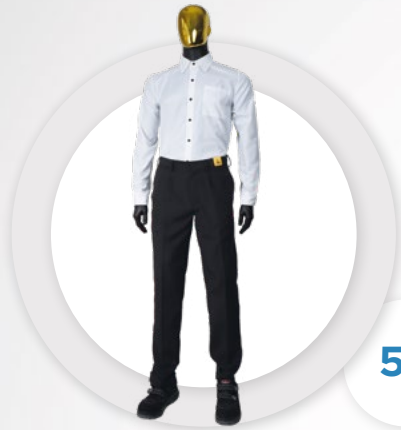

50

ING ESD MALE BUSINESS SHIRT



51

IFG ESD FEMALE BUSINESS SHIRT



52

NT ESD MALE SUITE PANTS



53

NTF ESD FEMALE SUITE PANTS



54

SKI ESD SKIRT

ING ESD MALE BUSINESS SHIRT



FEATURES

- » Standard sizes: Male XS - 5XL
- » Business style
- » 1 breast pocket
- » ESD logo on sleeve
- » Buttons

STANDARD FABRICS AND COLORS

KK01 FABRIC					TH55 FABRIC				TH65 FABRIC	
BK	DZ	DG	GA	LG	RB	LB	GA	W	W	
NB	RB	LB	MG	LE	CT35 FABRIC				eco EECO01 FABRIC	
B	R	O	Y	LPK	W	OEKO TEX RB LB W				
W										



DEMO VIDEO



ORDERING CODE SAMPLE

ING - **KK01** - **W L**
 style fabric color size



You can contact us too for customized embroidered or screen printed company logos, lettering, custom designed ESD clothing.

Clothing certified according to the international ESD standards, as indicated by this/similar label



DETAILS ON PAGE 112

SIZE CHART (CM)	XS	S	M	L	XL	XXL	3XL	4XL	5XL
Sleeve	56	58	60	62	64	66	68	70	70
Length	66	68	70	72	74	76	78	80	80
Chest	94	100	106	112	118	124	130	136	142
Shoulder	39	41	43	45	47	49	51	54	57
Cuff outline	23	24	25	26	27	28	29	30	31

Size tolerance (before washing): 2%

IFG ESD FEMALE BUSINESS SHIRT



Models with OEKO-TEX® STANDARD 100 certification are also available



Economy – products with economy price

FEATURES

- » Standard sizes: Female XS - 5XL
- » ESD logo on sleeve
- » Buttons

STANDARD FABRICS AND COLORS

TH65 FABRIC



TH55 FABRIC



KK01 FABRIC



eco EECO01 FABRIC



CT35 FABRIC



Color swatches for KK01 fabric



You can contact us too for customized embroidered or screen printed company logos, lettering, custom designed ESD clothing.

ORDERING CODE SAMPLE

IFG - **KK01** - **W** **L**
 style fabric color size

DEMO VIDEO



DETAILS ON PAGE 112

SIZE CHART (CM)	XS	S	M	L	XL	XXL	3XL	4XL	5XL
Sleeve	56	58	60	62	64	66	68	70	70
Length	56	58	60	62	64	66	68	70	70
Chest	84	88	92	96	100	104	108	112	116
Shoulder	40	40	42	44	46	48	50	52	54
Cuff outline	21	22	23	24	25	26	27	28	29

Size tolerance (before washing): 2%



Clothing certified according to the international ESD standards, as indicated by this/similar label

NT ESD MALE SUITE PANTS



FEATURES

- » Standard sizes: Male XS - 5XL
- » Straight cut
- » 2 side pockets, 1 hip pocket
- » ESD logo on the waist

STANDARD FABRICS AND COLORS

KK01 FABRIC					TH55 FABRIC				TH65 FABRIC	
BK	DZ	DG	GA	LG	RB	LB	GA	W	W	
NB	RB	LB	MG	LE	CT35 FABRIC				eco EECO01 FABRIC	
B	R	O	Y	LPK	W	OEKO-TEX® RB LB W				
W										



DEMO VIDEO



ORDERING CODE SAMPLE

NT - **KK01** - **BK** **L**
 style fabric color size



You can contact us too for customized embroidered or screen printed company logos, lettering, custom designed ESD clothing.

Clothing certified according to the international ESD standards, as indicated by this/similar label



DETAILS ON PAGE 113

SIZE CHART (CM)	XS	S	M	L	XL	XXL	3XL	4XL	5XL
Waist	80	84	88	92	96	100	104	109	113
Hip	98	102	107	111	115	119	123	128	132
Length external	102	104	106	108	110	112	114	116	118

Size tolerance (before washing): 2%

NTF ESD FEMALE SUITE PANTS



Models with OEKO-TEX® STANDARD 100 certification are also available



Economy – products with economy price

FEATURES

- » Standard sizes: Female XS - 5XL
- » Straight cut
- » 2 side pockets
- » ESD logo on the waist

STANDARD FABRICS AND COLORS

TH65 FABRIC



TH55 FABRIC



KK01 FABRIC



ECCO01 FABRIC



CT35 FABRIC



ORDERING CODE SAMPLE

NTF - **KK01** - **BK L**
 style fabric color size

DEMO VIDEO



You can contact us too for customized embroidered or screen printed company logos, lettering, custom designed ESD clothing.

DETAILS ON PAGE 113

SIZE CHART (CM)	XS	S	M	L	XL	XXL	3XL	4XL	5XL
Waist	68	72	76	80	84	88	92	97	101
Hip	98	102	107	111	115	119	123	128	132
Length external	102	104	106	108	110	112	114	116	118

Size tolerance (before washing): 2%



Clothing certified according to the international ESD standards, as indicated by this/similar label

SKI ESD SKIRT



OEKO TEX® STANDARD 100 25.3.0243 INNOVATEXT
Models with OEKO-TEX® STANDARD 100 certification are also available

eco
Economy – products with economy price

FEATURES

- » Standard sizes: XS – 5XL
- » Length: knee-high
- » Pencil style
- » With ESD logo

STANDARD FABRICS AND COLORS

KK01 FABRIC					TH55 FABRIC				TH65 FABRIC	
BK	DZ	DG	GA	LG	RB	LB	GA	W	W	
NB	RB	LB	MG	LE	CT35 FABRIC				eco EECO01 FABRIC	
B	R	O	Y	LPK	W	OEKO TEX®	RB	LB	W	
W										

VIDEO / WEBPAGE



ORDERING CODE SAMPLE

SKI - KK01 - BK L
style fabric color size



You can contact us too for customized embroidered or screen printed company logos, lettering, custom designed ESD clothing.

Clothing certified according to the international ESD standards, as indicated by this/similar label



DETAILS ON PAGE 113

SIZE CHART (CM)	XS	S	M	L	XL	XXL	3XL	4XL	5XL
Waist	76	80	84	88	92	96	100	104	108
Hip	98	102	106	110	114	118	122	126	130
Length	59	61	63	65	67	69	71	71	71

Size tolerance (before washing): 2%



+36 27 502 555
SALES@DESTSA.HU
WWW.DLB.HU





SUMMER LINE

CLOTHING STYLES



58

TKO/F ESD T-SHIRT

ROUND NECK, NO POCKET



59

TKZ/F ESD T-SHIRT

ROUND NECK, BREAST POCKET



60

LKO/F ESD T-SHIRT

ROUND NECK, NO POCKET



61

LKZ/F ESD T-SHIRT

ROUND NECK, BREAST POCKET



62

TGO/F ESD T-SHIRT

V-NECK, NO POCKET



63

TGZ/F ESD T-SHIRT

V-NECK, BREAST POCKET



64

LGO/F ESD T-SHIRT

V-NECK, NO POCKET



65

LGZ/F ESD T-SHIRT

V-NECK, BREAST POCKET



66

PGO/F ESD POLO-SHIRT

COLLAR, NO POCKET



67

PGZ/F ESD POLO-SHIRT

COLLAR, BREAST POCKET



68

QGO/F ESD POLO-SHIRT

COLLAR, NO POCKET



69

QGZ/F ESD POLO-SHIRT

COLLAR, BREAST POCKET



70

TLY ESD STRETCH T-SHIRT

ROUND NECK, NO POCKET

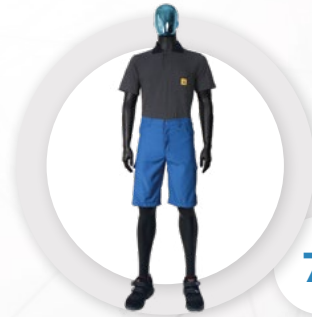

71

RGA ESD SHORTS

TKO/F ESD T-SHIRT

SHORT SLEEVE, ROUND NECK, NO POCKET

FEATURES

- » Standard sizes: Unisex XS - 5XL, female (F) XS - 5XL
- » **Female model:** Slim style
- » Round neck
- » Without any pocket
- » ESD logo on sleeve

STANDARD FABRICS AND COLORS

TS15 FABRIC		EECO-TS15 FABRIC	TS16 FABRIC
PS21 FABRIC		EECO-PS21 FABRIC	

Models with **OEKO-TEX® STANDARD 100** certification are also available

Economy – products with economy price

VIDEO / WEBPAGE



ORDERING CODE SAMPLE

TKOF - **TS15** - **BK L**
 style female fabric color size

The sizechart below shows the dimensions before washing. After washing, it should be calculated with a shrinkage of 8-10% for width (mainly for breast size).

You can contact us too for customized embroidered or screen printed company logos, lettering, custom designed ESD clothing.

Clothing certified according to the international ESD standards, as indicated by this/similar label



The sizes given here meant values before washing. **DETAILS AND FEMALE SIZE CHART ON PAGE 112**

SIZE CHART (CM)	XS	S	M	L	XL	XXL	3XL	4XL	5XL
Sleeve	20,5	21,5	22,5	23,5	25	26,5	28	29,5	31
Length	63	66	69	72	75	78	81	84	87
Chest	100	106	112	118	124	130	136	142	148
Shoulder	41	43	45	47	49	51	54	57	60

Size tolerance (before washing): 2%

We suggest to determine personal size with measurement on washed clothes.

TKZ/F ESD T-SHIRT

SHORT SLEEVE, ROUND NECK, BREAST POCKET

FEATURES

- » Standard sizes: Unisex XS - 5XL, female (F) XS - 5XL
- » Female model: Slim style
- » Round neck
- » Breast pocket with ESD logo

STANDARD FABRICS AND COLORS

TS16 FABRIC



eco EECO-TS15 FABRIC

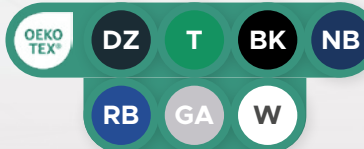

TS15 FABRIC

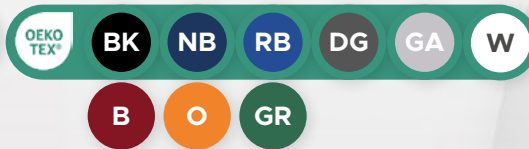

eco EECO-PS21 FABRIC



PS21 FABRIC



ORDERING CODE SAMPLE

TKZF - **TS15** - **GA L**
 style female fabric color size

VIDEO / WEBPAGE



OEKO-TEX® STANDARD 100
 25.3.0243 INNOVATEX
 Models with **OEKO-TEX®** STANDARD 100 certification are also available

eco
 Economy – products with economy price

!
 The sizechart below shows the dimensions before washing. After washing, it should be calculated with a shrinkage of 8-10% for width (mainly for breast size).

i
 You can contact us too for customized embroidered or screen printed company logos, lettering, custom designed ESD clothing.

The sizes given here meant values before washing.

DETAILS AND FEMALE SIZE CHART ON PAGE 112

SIZE CHART (CM)	XS	S	M	L	XL	XXL	3XL	4XL	5XL
Sleeve	20,5	21,5	22,5	23,5	25	26,5	28	29,5	31
Length	63	66	69	72	75	78	81	84	87
Chest	100	106	112	118	124	130	136	142	148
Shoulder	41	43	45	47	49	51	54	57	60



Clothing certified according to the international ESD standards, as indicated by this/similar label

Size tolerance (before washing): 2%

We suggest to determine personal size with measurement on washed clothes. **!**

LKO/F ESD T-SHIRT

LONG SLEEVE, ROUND NECK, NO POCKET

FEATURES

- » Standard sizes: Unisex XS - 5XL, female (F) XS - 5XL
- » **Female model:** Slim style
- » Round neck
- » Without any pocket
- » ESD logo on sleeve

STANDARD FABRICS AND COLORS

TS15 FABRIC		EECO-TS15 FABRIC	TS16 FABRIC
PS21 FABRIC		EECO-PS21 FABRIC	

OEKO TEX® STANDARD 100 25.3.0243 INNOVATEXT
Models with **OEKO-TEX®** STANDARD 100 certification are also available

Economy – products with economy price



VIDEO / WEBPAGE



ORDERING CODE SAMPLE

LKOF - **TS15** - **BK** **L**
style female fabric color size

The sizechart below shows the dimensions before washing. After washing, it should be calculated with a shrinkage of 8-10% for width (mainly for breast size).

You can contact us too for customized embroidered or screen printed company logos, lettering, custom designed ESD clothing.

Clothing certified according to the international ESD standards, as indicated by this/similar label



SIZE CHART (CM)	XS	S	M	L	XL	XXL	3XL	4XL	5XL
Sleeve	51,5	53	57	61	63	65	67	67	68
Length	63	66	69	72	75	78	81	84	87
Chest	100	106	112	118	124	130	136	142	148
Shoulder	41	43	45	47	49	51	54	57	60

The sizes given here meant values before washing. **DETAILS AND FEMALE SIZE CHART ON PAGE 112**

Size tolerance (before washing): 2%

We suggest to determine personal size with measurement on washed clothes.

LKZ/F ESD T-SHIRT

LONG SLEEVE, ROUND NECK, BREAST POCKET

FEATURES

- » Standard sizes: Unisex XS - 5XL, female (F) XS - 5XL
- » Female model: Slim style
- » Round neck
- » Breast pocket with ESD logo

STANDARD FABRICS AND COLORS

TS16 FABRIC



eco EECO-TS15 FABRIC

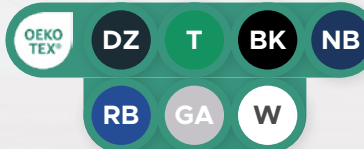

TS15 FABRIC

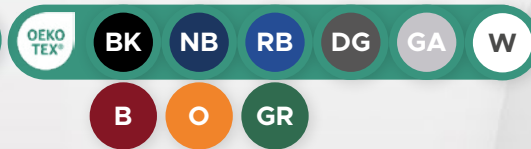

eco EECO-PS21 FABRIC



PS21 FABRIC



ORDERING CODE SAMPLE

LKZF - **TS15** - **GA** **L**
 style female fabric color size

VIDEO / WEBPAGE



OEKO-TEX® STANDARD 100
 25.3.0243 INNOVATEX
 Models with **OEKO-TEX®** STANDARD 100 certification are also available

eco
 Economy – products with economy price

The sizechart below shows the dimensions before washing. After washing, it should be calculated with a shrinkage of 8-10% for width (mainly for breast size).

You can contact us too for customized embroidered or screen printed company logos, lettering, custom designed ESD clothing.

The sizes given here meant values before washing.

DETAILS AND FEMALE SIZE CHART ON PAGE 112

SIZE CHART (CM)	XS	S	M	L	XL	XXL	3XL	4XL	5XL
Sleeve	51,5	53	57	61	63	65	67	67	68
Length	63	66	69	72	75	78	81	84	87
Chest	100	106	112	118	124	130	136	142	148
Shoulder	41	43	45	47	49	51	54	57	60

Size tolerance (before washing): 2%

We suggest to determine personal size with measurement on washed clothes.



Clothing certified according to the international ESD standards, as indicated by this/similar label

TGO/F ESD T-SHIRT

SHORT SLEEVE, V-NECK, NO POCKET

FEATURES

- » Standard sizes: Unisex XS - 5XL, female (F) XS - 5XL
- » **Female model:** Slim style
- » V-neck
- » Without any pocket
- » ESD logo on sleeve

STANDARD FABRICS AND COLORS

TS15 FABRIC		EECO-TS15 FABRIC	TS16 FABRIC
BK NB RB DG GA W		DZ T BK NB	BK NB W
B O GR		RB GA W	
PS21 FABRIC		EECO-PS21 FABRIC	
BK NB RB PR		BK NB RB PR	
DG GA W			

STANDARD 100
25.3.0243
INNOVATEXT

Models with **OEKO-TEX®**
STANDARD 100 certification
are also available

Economy – products
with economy price

The sizechart below shows the dimensions before washing. After washing, it should be calculated with a shrinkage of 8-10% for width (mainly for breast size).

You can contact us too for customized embroidered or screen printed company logos, lettering, custom designed ESD clothing.



VIDEO / WEBPAGE



ORDERING CODE SAMPLE

TGOF - **TS15** - **GR L**
style female fabric color size

Clothing certified according to the international ESD standards, as indicated by this/similar label



The sizes given here meant values before washing.
DETAILS AND FEMALE SIZE CHART ON PAGE 112

SIZE CHART (CM)	XS	S	M	L	XL	XXL	3XL	4XL	5XL
Sleeve	20,5	21,5	22,5	23,5	25	26,5	28	29,5	31
Length	63	66	69	72	75	78	81	84	87
Chest	100	106	112	118	124	130	136	142	148
Shoulder	41	43	45	47	49	51	54	57	60

Size tolerance (before washing): 2%

We suggest to determine personal size with measurement on washed clothes.

TGZ/F ESD T-SHIRT

SHORT SLEEVE, V-NECK, BREAST POCKET

FEATURES

- » Standard sizes: Unisex XS - 5XL, female (F) XS - 5XL
- » Female model: Slim style
- » V-neck
- » Breast pocket with ESD logo

STANDARD FABRICS AND COLORS

TS16 FABRIC



eco EECO-TS15 FABRIC

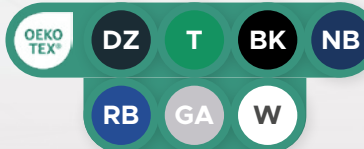

TS15 FABRIC

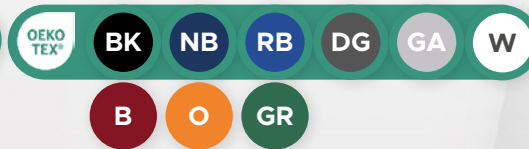

eco EECO-PS21 FABRIC



PS21 FABRIC



ORDERING CODE SAMPLE

TGZF - **TS15** - **NB** **L**
 style female fabric color size

VIDEO / WEBPAGE



OEKO-TEX® STANDARD 100
 25.3.0243 INNOVATEX
 Models with **OEKO-TEX®** STANDARD 100 certification are also available

eco
 Economy – products with economy price

The sizechart below shows the dimensions before washing. After washing, it should be calculated with a shrinkage of 8-10% for width (mainly for breast size).

You can contact us too for customized embroidered or screen printed company logos, lettering, custom designed ESD clothing.

The sizes given here meant values before washing.

DETAILS AND FEMALE SIZE CHART ON PAGE 112

SIZE CHART (CM)	XS	S	M	L	XL	XXL	3XL	4XL	5XL
Sleeve	20,5	21,5	22,5	23,5	25	26,5	28	29,5	31
Length	63	66	69	72	75	78	81	84	87
Chest	100	106	112	118	124	130	136	142	148
Shoulder	41	43	45	47	49	51	54	57	60



Clothing certified according to the international ESD standards, as indicated by this/similar label

Size tolerance (before washing): 2%

We suggest to determine personal size with measurement on washed clothes.

LGO/F ESD T-SHIRT

LONG SLEEVE, V-NECK, NO POCKET

FEATURES

- » Standard sizes: Unisex XS - 5XL, female (F) XS - 5XL
- » **Female model:** Slim style
- » V-neck
- » Without any pocket
- » ESD logo on sleeve

STANDARD FABRICS AND COLORS

TS15 FABRIC		EECO-TS15 FABRIC	TS16 FABRIC
PS21 FABRIC		EECO-PS21 FABRIC	

OEKO-TEX® STANDARD 100
25.3.0243 INNOVATEX
Models with **OEKO-TEX®** STANDARD 100 certification are also available

Economy – products with economy price



VIDEO / WEBPAGE



ORDERING CODE SAMPLE

LGOF - **TS15** - **GR**L
style female fabric color size

The sizechart below shows the dimensions before washing. After washing, it should be calculated with a shrinkage of 8-10% for width (mainly for breast size).

You can contact us too for customized embroidered or screen printed company logos, lettering, custom designed ESD clothing.

Clothing certified according to the international ESD standards, as indicated by this/similar label



SIZE CHART (CM)	XS	S	M	L	XL	XXL	3XL	4XL	5XL
Sleeve	51,5	53	57	61	63	65	67	67	68
Length	63	66	69	72	75	78	81	84	87
Chest	100	106	112	118	124	130	136	142	148
Shoulder	41	43	45	47	49	51	54	57	60

The sizes given here meant values before washing. **DETAILS AND FEMALE SIZE CHART ON PAGE 112**

Size tolerance (before washing): 2%

We suggest to determine personal size with measurement on washed clothes.

LGZ/F ESD T-SHIRT

LONG SLEEVE, V-NECK, BREAST POCKET

FEATURES

- » Standard sizes: Unisex XS - 5XL, female (F) XS - 5XL
- » **Female model:** Slim style
- » V-neck
- » Breast pocket with ESD logo

STANDARD FABRICS AND COLORS

TS16 FABRIC



eco EECO-TS15 FABRIC

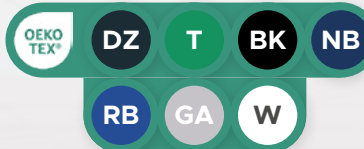

TS15 FABRIC

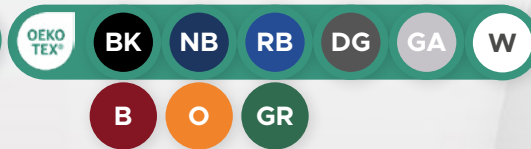

eco EECO-PS21 FABRIC



PS21 FABRIC



ORDERING CODE SAMPLE

LGZF - **TS15** - **NB L**
 style female fabric color size

VIDEO / WEBPAGE





Models with **OEKO-TEX® STANDARD 100** certification are also available



Economy – products with economy price



The sizechart below shows the dimensions before washing. After washing, it should be calculated with a shrinkage of 8-10% for width (mainly for breast size).



You can contact us too for customized embroidered or screen printed company logos, lettering, custom designed ESD clothing.

The sizes given here meant values before washing.

DETAILS AND FEMALE SIZE CHART ON PAGE 112

SIZE CHART (CM)	XS	S	M	L	XL	XXL	3XL	4XL	5XL
Sleeve	51,5	53	57	61	63	65	67	67	68
Length	63	66	69	72	75	78	81	84	87
Chest	100	106	112	118	124	130	136	142	148
Shoulder	41	43	45	47	49	51	54	57	60



Clothing certified according to the international ESD standards, as indicated by this/similar label

Size tolerance (before washing): 2%

We suggest to determine personal size with measurement on washed clothes. 

PGO/F ESD POLO-SHIRT

SHORT SLEEVE, COLLAR, NO POCKET

FEATURES

- » Standard sizes: Unisex XS - 5XL, female (F) XS - 5XL
- » **Female model:** Slim style
- » Without any pocket
- » ESD logo on sleeve
- » Hidden snap-fasteners

OPTIONAL

- + Collar from its own fabric
CODE: SAA

STANDARD FABRICS AND COLORS

TS15 FABRIC

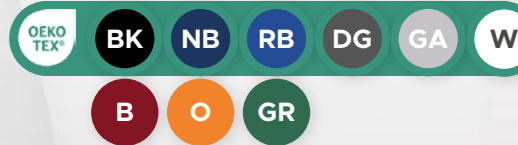

EECO-TS15 FABRIC

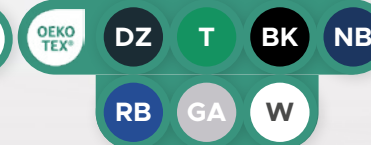

TS16 FABRIC



PS21 FABRIC



EECO-PS21 FABRIC

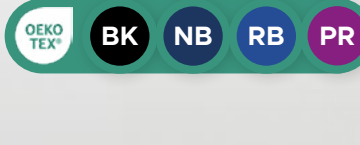

OEKO-TEX® STANDARD 100
25.3.0243 INNOVATEX
Models with **OEKO-TEX®** STANDARD 100 certification are also available

eco
Economy – products with economy price

VIDEO / WEBPAGE



ORDERING CODE SAMPLE

PGOF - **PS21** - **NB** **L**
style female fabric color size

!
The sizechart below shows the dimensions before washing. After washing, it should be calculated with a shrinkage of 8-10% for width (mainly for breast size).

i
You can contact us too for customized embroidered or screen printed company logos, lettering, custom designed ESD clothing.

Clothing certified according to the international ESD standards, as indicated by this/similar label



SIZE CHART (CM)	XS	S	M	L	XL	XXL	3XL	4XL	5XL
Sleeve	20,5	21,5	22,5	23,5	25	26,5	28	29,5	31
Length	63	66	69	72	75	78	81	84	87
Chest	100	106	112	118	124	130	136	142	148
Shoulder	41	43	45	47	49	51	54	57	60

The sizes given here meant values before washing. **DETAILS AND FEMALE SIZE CHART ON PAGE 112**

Size tolerance (before washing): 2%

! We suggest to determine personal size with measurement on washed clothes.

PGZ/F ESD POLO-SHIRT

SHORT SLEEVE, COLLAR, BREAST POCKET

OPTIONAL

- Collar from its own fabric
CODE: SAA

FEATURES

- » Standard sizes: Unisex XS - 5XL, female (F) XS - 5XL
- » Female model: Slim style
- » Breast pocket with ESD logo
- » Hidden snap-fasteners

STANDARD FABRICS AND COLORS

TS16 FABRIC



eco EECO-TS15 FABRIC

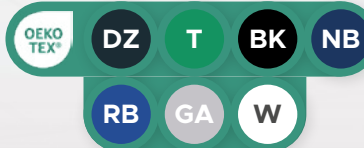

TS15 FABRIC

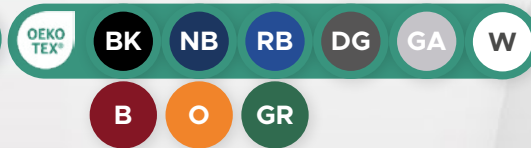

eco EECO-PS21 FABRIC



PS21 FABRIC



The sizechart below shows the dimensions before washing. After washing, it should be calculated with a shrinkage of 8-10% for width (mainly for breast size).



You can contact us too for customized embroidered or screen printed company logos, lettering, custom designed ESD clothing.

ORDERING CODE SAMPLE

PGZF - PS21 - RB L
style female fabric color size

VIDEO / WEBPAGE



The sizes given here meant values before washing.

DETAILS AND FEMALE SIZE CHART ON PAGE 112

SIZE CHART (CM)	XS	S	M	L	XL	XXL	3XL	4XL	5XL
Sleeve	20,5	21,5	22,5	23,5	25	26,5	28	29,5	31
Length	63	66	69	72	75	78	81	84	87
Chest	100	106	112	118	124	130	136	142	148
Shoulder	41	43	45	47	49	51	54	57	60



Clothing certified according to the international ESD standards, as indicated by this/similar label

Size tolerance (before washing): 2%

We suggest to determine personal size with measurement on washed clothes.

QGO/F ESD POLO-SHIRT

LONG SLEEVE, COLLAR, NO POCKET

FEATURES

- » Standard sizes: Unisex XS - 5XL, female (F) XS - 5XL
- » **Female model:** Slim style
- » Without any pocket
- » ESD logo on sleeve
- » Hidden snap-fasteners

OPTIONAL

- + Collar from its own fabric
CODE: SAA

STANDARD FABRICS AND COLORS

OEKO-TEX® STANDARD 100
25.3.0243 INNOVATEX
Models with **OEKO-TEX® STANDARD 100** certification are also available

eco
Economy – products with economy price

VIDEO / WEBPAGE



<p>TS15 FABRIC</p> <p>OEKO-TEX® BK NB RB DG GA W</p> <p>B O GR</p>	<p>eco EECO-TS15 FABRIC</p> <p>OEKO-TEX® DZ T BK NB</p> <p>RB GA W</p>	<p>TS16 FABRIC</p> <p>BK NB W</p>
<p>PS21 FABRIC</p> <p>BK NB RB PR</p> <p>DG GA W</p>	<p>eco EECO-PS21 FABRIC</p> <p>OEKO-TEX® BK NB RB PR</p>	

!
The sizechart below shows the dimensions before washing. After washing, it should be calculated with a shrinkage of 8-10% for width (mainly for breast size).

ORDERING CODE SAMPLE

QGO**F** - **PS21** - **NB** **L**
style female fabric color size

i
You can contact us too for customized embroidered or screen printed company logos, lettering, custom designed ESD clothing.

Clothing certified according to the international ESD standards, as indicated by this/similar label



SIZE CHART (CM)	XS	S	M	L	XL	XXL	3XL	4XL	5XL
Sleeve	51,5	53	57	61	63	65	67	67	68
Length	63	66	69	72	75	78	81	84	87
Chest	100	106	112	118	124	130	136	142	148
Shoulder	41	43	45	47	49	51	54	57	60

The sizes given here meant values before washing. **DETAILS AND FEMALE SIZE CHART ON PAGE 112**

Size tolerance (before washing): 2%

! We suggest to determine personal size with measurement on washed clothes.

QGZ/F ESD POLO-SHIRT

LONG SLEEVE, COLLAR, BREAST POCKET

OPTIONAL

- Collar from its own fabric
CODE: SAA

FEATURES

- Standard sizes: Unisex XS - 5XL, female (F) XS - 5XL
- Female model: Slim style
- Breast pocket with ESD logo
- Hidden snap-fasteners

STANDARD FABRICS AND COLORS

TS16 FABRIC

EECO-TS15 FABRIC

TS15 FABRIC

EECO-PS21 FABRIC

PS21 FABRIC



The sizechart below shows the dimensions before washing. After washing, it should be calculated with a shrinkage of 8-10% for width (mainly for breast size).



You can contact us too for customized embroidered or screen printed company logos, lettering, custom designed ESD clothing.

Models with OEKO-TEX® STANDARD 100 certification are also available

Economy – products with economy price

ORDERING CODE SAMPLE

QGZF - PS21 - RB L
 style female fabric color size

VIDEO / WEBPAGE

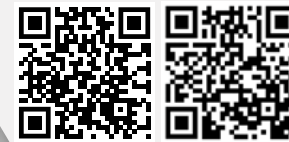

The sizes given here meant values before washing.

DETAILS AND FEMALE SIZE CHART ON PAGE 112

SIZE CHART (CM)	XS	S	M	L	XL	XXL	3XL	4XL	5XL
Sleeve	51,5	53	57	61	63	65	67	67	68
Length	63	66	69	72	75	78	81	84	87
Chest	100	106	112	118	124	130	136	142	148
Shoulder	41	43	45	47	49	51	54	57	60



Clothing certified according to the international ESD standards, as indicated by this/similar label

Size tolerance (before washing): 2%

We suggest to determine personal size with measurement on washed clothes.

TLY ESD STRETCH T-SHIRT

SHORT SLEEVE, ROUND NECK, NO POCKET

FEATURES

- » Standard sizes: Unisex XS - 5XL
- » Slim style, stretch material
- » Round neck
- » Short sleeve
- » Without any pocket
- » ESD logo on sleeve
- » Comfortable, breathable

STANDARD FABRIC AND COLOR

LY20 FABRIC

BK



You can contact us too for customized embroidered or screen printed company logos, lettering, custom designed ESD clothing.



The sizechart below shows the dimensions before washing.
After washing, it should be calculated with a shrinkage of 8-10% for width (mainly for breast size).

ORDERING CODE SAMPLE

TLY - **LY20** - **BK** **L**
style fabric color size

DEMO VIDEO



Clothing certified according to the international ESD standards, as indicated by this/similar label



The sizes given here meant values before washing.
DETAILS AND FEMALE SIZE CHART ON PAGE 112

SIZE CHART (CM)	XS	S	M	L	XL	XXL	3XL	4XL	5XL
Sleeve	19,5	20,5	21,5	22,5	23,5	25	26,5	28	29,5
Length	56	59	62	65	68	71	74	77	80
Chest	94	100	106	112	118	124	130	136	142
Shoulder	39	41	43	45	47	49	51	54	57

Size tolerance (before washing): 2%

! We suggest to determine personal size with measurement on washed clothes.

RG A ESD SHORTS

- » Standard sizes: Male XS - 5XL
- » Straight style
- » 2 side pockets, 1 hip pocket with ESD logo

- » 1 side pocket on the leg
- » 1 tool pocket on the leg
- » Rubberized waist with snap-fastener

FEATURES

STANDARD FABRICS AND COLORS

TH65 FABRIC

W

TH55 FABRIC

RB LB GA W

KK01 FABRIC

BK DZ DG GA LG

eco EECO01 FABRIC

OEKO TEX RB LB W

CT35 FABRIC

W

NB RB LB MG LE

B R O Y LPK

W



You can contact us too for customized embroidered or screen printed company logos, lettering, custom designed ESD clothing.

ORDERING CODE SAMPLE

RG A - **TH55** - **RB** **L**
 style fabric color size

DEMO VIDEO



DETAILS ON PAGE 113

SIZE CHART (CM)	XS	S	M	L	XL	XXL	3XL	4XL	5XL
Length external	49	51	53	55	57	59	61	63	65
Hip	98	102	107	111	115	119	123	128	132

Size tolerance (before washing): 2%



Clothing certified according to the international ESD standards, as indicated by this/similar label



WINTER LINE

CLOTHING STYLES



74

CAS ESD CARDIGAN

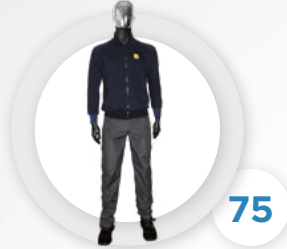

75

CAL ESD CARDIGAN

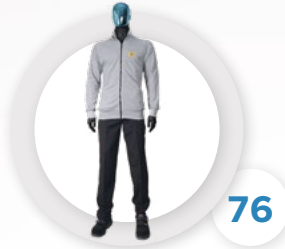

76

CAL-H ESD CARDIGAN

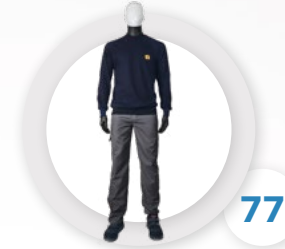

77

SWS ESD SWEATSHIRT

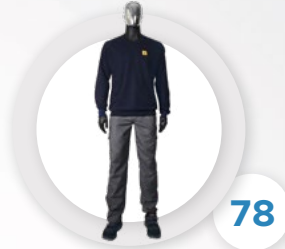

78

SGS ESD SWEATSHIRT

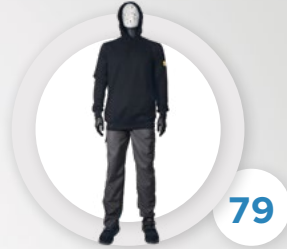

79

SKS ESD SWEATSHIRT

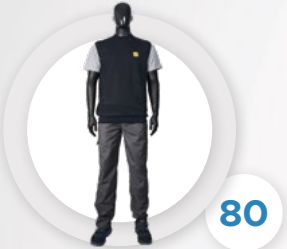

80

SGW ESD VEST

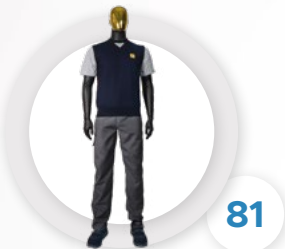

81

SWW ESD VEST



82

SWW-Z ESD VEST

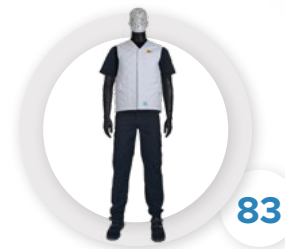

83

VES-S ESD QUILTED VEST



84

VES-H ESD QUILTED VEST

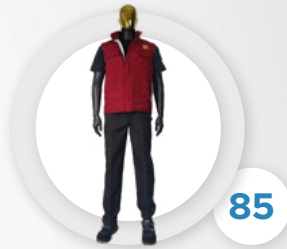

85

VES-T ESD VEST

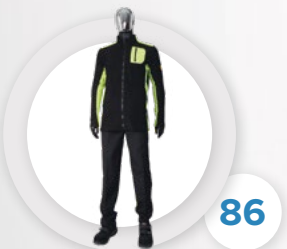

86

FCU ESD CARDIGAN

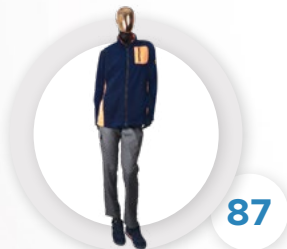

87

FCF ESD CARDIGAN



88

FBU ESD CARDIGAN



89

FBF ESD CARDIGAN



90

FSU ESD CARDIGAN



91

FFF ESD CARDIGAN



92

WJ ESD WINTER JACKET



93

WW ESD WINTER VEST



94

WN ESD WINTER TROUSERS



96

WH ESD WINTER HAT

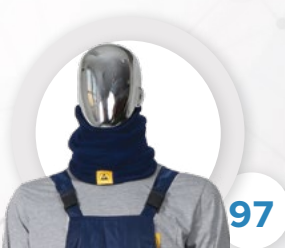

97

WS ESD TUBE SCARF

CAS ESD CARDIGAN



SHORT ZIPPER

FEATURES

- » Standard sizes: Unisex XS - 5XL
- » With short zipper
- » 2 side pockets
- » ESD logo on the chest area
- » ESD cuff
- » Comfortable, breathable

STANDARD FABRICS AND COLORS

THSS FABRIC



THSB FABRIC



You can contact us too for customized embroidered or screen printed company logos, lettering, custom designed ESD clothing.



The sizechart below shows the dimensions before washing.
After washing, it should be calculated with a shrinkage of 8-10% for width (mainly for breast size).

DEMO VIDEO



ORDERING CODE SAMPLE

CAS - THSS - RB L
style fabric color size

The sizes given here meant values before washing.

DETAILS ON PAGE 113

Clothing certified according to the international ESD standards, as indicated by this/similar label



SIZE CHART (CM)	XS	S	M	L	XL	XXL	3XL	4XL	5XL
Chest	108	112	116	120	124	130	136	142	148
Length	64	66	68	70	72	74	76	78	80
Sleeve	72	74	76	78	80	82	84	84	85

Size tolerance (before washing): 2%

! We suggest to determine personal size with measurement on washed clothes.

CAL ESD CARDIGAN

LONG ZIPPER 

FEATURES

- » Standard sizes: Unisex XS - 5XL
- » With full length zipper
- » 2 side pockets
- » ESD logo on the chest area
- » ESD cuff
- » Comfortable, breathable

STANDARD FABRICS AND COLORS

THSS FABRIC 



THSB FABRIC 



You can contact us too for customized embroidered or screen printed company logos, lettering, custom designed ESD clothing. 

The sizechart below shows the dimensions before washing. After washing, it should be calculated with a shrinkage of 8-10% for width (mainly for breast size). 

ORDERING CODE SAMPLE

CAL - **THSS** - **NB L**
 style fabric color size

DEMO VIDEO 



The sizes given here meant values before washing.

DETAILS ON PAGE 113

SIZE CHART (CM)	XS	S	M	L	XL	XXL	3XL	4XL	5XL
Chest	108	112	116	120	124	130	136	142	148
Length	64	66	68	70	72	74	76	78	80
Sleeve	72	74	76	78	80	82	84	84	85

Size tolerance (before washing): 2%

We suggest to determine personal size with measurement on washed clothes. 



Clothing certified according to the international ESD standards, as indicated by this/similar label

CAL-H ESD CARDIGAN

LONG ZIPPER, STANDING COLLAR

FEATURES

- » Standard sizes: Unisex XS - 5XL
- » Standing collar
- » With full length zipper
- » 2 side pockets
- » ESD logo on the chest area
- » ESD cuff
- » Comfortable, breathable

STANDARD FABRICS AND COLORS

THSS FABRIC



THSB FABRIC



You can contact us too for customized embroidered or screen printed company logos, lettering, custom designed ESD clothing.



The sizechart below shows the dimensions before washing.
After washing, it should be calculated with a shrinkage of 8-10% for width (mainly for breast size).

ORDERING CODE SAMPLE

CAL-H - **THSS** - **GA** **L**
style fabric color size

VIDEO / WEBPAGE



Clothing certified according to the international ESD standards, as indicated by this/similar label



The sizes given here meant values before washing.

DETAILS ON PAGE 113

SIZE CHART (CM)	XS	S	M	L	XL	XXL	3XL	4XL	5XL
Chest	108	112	116	120	124	130	136	142	148
Length	64	66	68	70	72	74	76	78	80
Sleeve	72	74	76	78	80	82	84	84	85

Size tolerance (before washing): 2%

! We suggest to determine personal size with measurement on washed clothes.

SWS ESD SWEATSHIRT

ROUND NECK 

FEATURES

- » Standard sizes: Unisex XS - 5XL
- » Round neck
- » ESD logo on the chest area
- » ESD cuff

STANDARD FABRICS AND COLORS

THSS FABRIC 



THSB FABRIC 



You can contact us too for customized embroidered or screen printed company logos, lettering, custom designed ESD clothing. 

The sizechart below shows the dimensions before washing. After washing, it should be calculated with a shrinkage of 8-10% for width (mainly for breast size). 

ORDERING CODE SAMPLE

SWS - **THSS** - **NB** **L**
 style fabric color size

DEMO VIDEO 



The sizes given here meant values before washing.

DETAILS ON PAGE 113

SIZE CHART (CM)	XS	S	M	L	XL	XXL	3XL	4XL	5XL
Chest	108	112	116	120	124	130	136	142	148
Length	64	66	68	70	72	74	76	78	80
Sleeve	72	74	76	78	80	82	84	84	85



Clothing certified according to the international ESD standards, as indicated by this/similar label

Size tolerance (before washing): 2%

We suggest to determine personal size with measurement on washed clothes. 

SGS ESD SWEATSHIRT



V-NECK

FEATURES

- » Standard sizes: Unisex XS - 5XL
- » V-neck
- » ESD logo on the chest area
- » ESD cuff

STANDARD FABRICS AND COLORS

THSS FABRIC



THSB FABRIC



You can contact us too for customized embroidered or screen printed company logos, lettering, custom designed ESD clothing.



The sizechart below shows the dimensions before washing.
After washing, it should be calculated with a shrinkage of 8-10% for width (mainly for breast size).

ORDERING CODE SAMPLE

SGS - **THSS** - **NB** **L**
 style fabric color size

DEMO VIDEO



Clothing certified according to the international ESD standards, as indicated by this/similar label



The sizes given here meant values before washing.

DETAILS ON PAGE 113

SIZE CHART (CM)	XS	S	M	L	XL	XXL	3XL	4XL	5XL
Chest	108	112	116	120	124	130	136	142	148
Length	64	66	68	70	72	74	76	78	80
Sleeve	72	74	76	78	80	82	84	84	85

Size tolerance (before washing): 2%

! We suggest to determine personal size with measurement on washed clothes.

SKS ESD HOODED SWEATSHIRT

FEATURES

- » Standard sizes: Unisex XS - 5XL
- » Hood with drawstring
- » With ESD logo on sleeve
- » ESD cuff
- » Kangaroo pocket

STANDARD FABRICS AND COLORS

THSS FABRIC



THSB FABRIC



You can contact us too for customized embroidered or screen printed company logos, lettering, custom designed ESD clothing.



The sizechart below shows the dimensions before washing.

After washing, it should be calculated with a shrinkage of 8-10% for width (mainly for breast size).



ORDERING CODE SAMPLE

SKS - **THSS** - **BK L**
 style fabric color size

DEMO VIDEO



The sizes given here meant values before washing.

DETAILS ON PAGE 112

SIZE CHART (CM)	XS	S	M	L	XL	XXL	3XL	4XL	5XL
Sleeve	52	53	57	61	63	65	67	67	68
Length	64	66	68	70	72	74	76	76	76
Chest	100	106	112	118	124	130	136	142	148
Shoulder	41	43	45	47	49	51	54	57	60



Clothing certified according to the international ESD standards, as indicated by this/similar label

Size tolerance (before washing): 2%

We suggest to determine personal size with measurement on washed clothes.

SGW ESD VEST



ROUND NECK

FEATURES

- » Standard sizes: Unisex XS - 5XL
- » Round neck
- » ESD logo on the chest area

STANDARD FABRICS AND COLORS

THSS FABRIC



THSB FABRIC



You can contact us too for customized embroidered or screen printed company logos, lettering, custom designed ESD clothing.



The sizechart below shows the dimensions before washing. After washing, it should be calculated with a shrinkage of 8-10% for width (mainly for breast size).

DEMO VIDEO



ORDERING CODE SAMPLE

SGW - **THSS** - **BK** **L**
 style fabric color size

The sizes given here meant values before washing.

DETAILS ON PAGE 113

Clothing certified according to the international ESD standards, as indicated by this/similar label



SIZE CHART (CM)	XS	S	M	L	XL	XXL	3XL	4XL	5XL
Chest	100	106	112	118	124	130	136	142	148
Length	63	66	69	72	75	78	81	84	87
Shoulder	41	43	45	47	49	51	54	57	60

Size tolerance (before washing): 2%

! We suggest to determine personal size with measurement on washed clothes.

SWW ESD VEST

V-NECK

FEATURES

- » Standard sizes: Unisex XS - 5XL
- » V-neck
- » ESD logo on the chest area

STANDARD FABRICS AND COLORS

THSS FABRIC



THSB FABRIC



You can contact us too for customized embroidered or screen printed company logos, lettering, custom designed ESD clothing.



The sizechart below shows the dimensions before washing. After washing, it should be calculated with a shrinkage of 8-10% for width (mainly for breast size).



ORDERING CODE SAMPLE

SWW - **THSS** - **NB** **L**
 style fabric color size

DEMO VIDEO



The sizes given here meant values before washing.

DETAILS ON PAGE 113

SIZE CHART (CM)	XS	S	M	L	XL	XXL	3XL	4XL	5XL
Chest	100	106	112	118	124	130	136	142	148
Length	63	66	69	72	75	78	81	84	87
Shoulder	41	43	45	47	49	51	54	57	60



Clothing certified according to the international ESD standards, as indicated by this/similar label

Size tolerance (before washing): 2%

We suggest to determine personal size with measurement on washed clothes.

SWW-Z ESD VEST

V-NECK, ZIPPER

FEATURES

- » Standard sizes: Unisex XS - 5XL
- » V-neck
- » With full length zipper
- » ESD logo on the chest area

STANDARD FABRICS AND COLORS

THSS FABRIC



THSB FABRIC



You can contact us too for customized embroidered or screen printed company logos, lettering, custom designed ESD clothing.



The sizechart below shows the dimensions before washing.
After washing, it should be calculated with a shrinkage of 8-10% for width (mainly for breast size).

ORDERING CODE SAMPLE

SWW-Z - THSS - GA L
style fabric color size

VIDEO / WEBPAGE



Clothing certified according to the international ESD standards, as indicated by this/similar label



The sizes given here meant values before washing.

DETAILS ON PAGE 113

SIZE CHART (CM)	XS	S	M	L	XL	XXL	3XL	4XL	5XL
Chest	100	106	112	118	124	130	136	142	148
Length	63	66	69	72	75	78	81	84	87
Shoulder	41	43	45	47	49	51	54	57	60

Size tolerance (before washing): 2%

! We suggest to determine personal size with measurement on washed clothes.

VES-S ESD QUILTED VEST

V-NECK

FEATURES

- » Standard sizes: Unisex XS - 5XL
- » Quilted lining
- » Hidden snap-fasteners
- » ESD logo on the chest area
- » 2 side pockets
- » Not waterproof

STANDARD FABRIC AND COLOR

CT35 FABRIC

W

You can contact us too for customized embroidered or screen printed company logos, lettering, custom designed ESD clothing.



ORDERING CODE SAMPLE

VES-S - **CT35** - **W** **L**
 style fabric color size

DEMO VIDEO



DETAILS ON PAGE 113

SIZE CHART (CM)	XS	S	M	L	XL	XXL	3XL	4XL	5XL
Chest	102	110	118	126	132	138	144	150	154
Length	64	66	68	70	72	74	76	78	80

Size tolerance (before washing): 2%



Clothing certified according to the international ESD standards, as indicated by this/similar label

VES-H ESD QUILTED VEST

ZIPPER, STANDING COLLAR

FEATURES

- » Standard sizes: Unisex XS - 5XL
- » Quilted lining
- » ESD logo on the chest area
- » 2 side pockets
- » Not waterproof

STANDARD FABRIC AND COLOR

CT35 FABRIC

W



You can contact us too for customized embroidered or screen printed company logos, lettering, custom designed ESD clothing.

ORDERING CODE SAMPLE

VES-H - **CT35** - **W L**
 style fabric color size

DEMO VIDEO



DETAILS ON PAGE 113

Clothing certified according to the international ESD standards, as indicated by this/similar label



SIZE CHART (CM)	XS	S	M	L	XL	XXL	3XL	4XL	5XL
Chest	102	110	118	126	132	138	144	150	154
Length	64	66	68	70	72	74	76	78	80

Size tolerance (before washing): 2%

VES-T ESD VEST

QUILTED LINING

FEATURES

- » Standard sizes: Unisex XS – 5XL
- » White, quilted lining
- » Zipper
- » ESD logo on the chest area
- » 2 side pockets
- » Not waterproof, for indoor use



Economy – products with economy price

STANDARD FABRICS AND COLORS

KK01 FABRIC

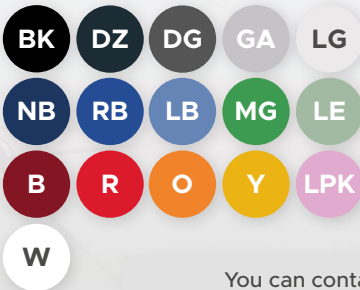

TH55 FABRIC



CR10HI FABRIC



WC10 FABRIC



CR10 FABRIC



CT35 FABRIC



eco EECO01 FABRIC



You can contact us too for customized embroidered or screen printed company logos, lettering, custom designed ESD clothing.



ORDERING CODE SAMPLE

VES-T - KK01 - B L
 style fabric color size

VIDEO / WEBPAGE



DETAILS ON PAGE 113

SIZE CHART (CM)	XS	S	M	L	XL	XXL	3XL	4XL	5XL
Chest	90	98	106	114	122	130	136	142	148
Length at the back	70	71	72	73	74	75	76	77	78

Size tolerance (before washing): 2%



Clothing certified according to the international ESD standards, as indicated by this/similar label

FCU ESD FLEECE CARDIGAN

LONG ZIPPER AND COLORED INSERTS

FEATURES

- » Standard sizes: Unisex XS – 5XL
- » Coloured inserts: **CR10HI-O or Y**
- » Zipper
- » Standing collar
- » ESD logo on sleeve
- » 2 side pockets, 1 breast pocket for identity card
- » Not waterproof, for indoor use

STANDARD FABRICS AND COLORS

FL1 FABRIC



FOR COLORED INSERTS

CR10HI FABRIC



You can contact us too for customized embroidered or screen printed company logos, lettering, custom designed ESD clothing.

ORDERING CODE SAMPLE

FCU - **FL1** - **BK** / **Y** **L**
style fabric color colored insert size

VIDEO / WEBPAGE



Clothing certified according to the international ESD standards, as indicated by this/similar label



DETAILS ON PAGE 112

SIZE CHART (CM)	XS	S	M	L	XL	XXL	3XL	4XL	5XL
Chest	102	106	110	114	118	122	126	130	134
Length	65	68	71	74	77	80	83	86	89
Sleeve	55	57	59	61	63	65	67	67	68
Shoulder	42	43	44	45	46	47	48	49	49

Size tolerance (before washing): 2%

FCF ESD FEMALE FLEECE CARDIGAN

LONG ZIPPER AND COLORED INSERTS

FEATURES

- » Standard sizes: Female XS – 5XL
- » Coloured inserts: **CR10HI-O or Y**
- » Zipper
- » Standing collar
- » ESD logo on sleeve
- » 2 side pockets, 1 breast pocket for identity card
- » Not waterproof, for indoor use

STANDARD FABRICS AND COLORS

FL1 FABRIC



FOR COLORED INSERTS

CR10HI FABRIC



You can contact us too for customized embroidered or screen printed company logos, lettering, custom designed ESD clothing.



ORDERING CODE SAMPLE

FCF - **FL1** - **NB** / **O** **L**
 style fabric color colored insert size

VIDEO / WEBPAGE



DETAILS ON PAGE 112

SIZE CHART (CM)	XS	S	M	L	XL	XXL	3XL	4XL	5XL
Chest	102	106	110	114	118	122	126	130	134
Length	62	65	68	71	74	77	80	83	83
Sleeve	55	57	59	61	63	65	67	67	68
Shoulder	42	43	44	45	46	47	48	49	49

Size tolerance (before washing): 2%



Clothing certified according to the international ESD standards, as indicated by this/similar label

FBU ESD FLEECE CARDIGAN

LONG ZIPPER AND INSIDE COLORED COLLAR

FEATURES

- » Standard sizes: Unisex XS – 5XL
- » Coloured inserts
- » Zipper
- » Standing collar
- » ESD logo on sleeve
- » 2 side pockets
- » Not waterproof, for indoor use

STANDARD FABRICS AND COLORS

FL1 FABRIC



FOR COLORED INSERTS

FL1 FABRIC



You can contact us too for customized embroidered or screen printed company logos, lettering, custom designed ESD clothing.

VIDEO / WEBPAGE



ORDERING CODE SAMPLE

FBU - **FL1** - **NB** / **Y** **L**
 style fabric color colored insert size

Clothing certified according to the international ESD standards, as indicated by this/similar label



DETAILS ON PAGE 112

SIZE CHART (CM)	XS	S	M	L	XL	XXL	3XL	4XL	5XL
Chest	102	106	110	114	118	122	126	130	134
Length	65	68	71	74	77	80	83	86	89
Sleeve	55	57	59	61	63	65	67	67	68
Shoulder	42	43	44	45	46	47	48	49	49

Size tolerance (before washing): 2%

FBF ESD FEMALE FLEECE CARDIGAN

LONG ZIPPER AND INSIDE COLORED COLLAR

FEATURES

- » Standard sizes: Female XS – 5XL
- » Coloured inserts
- » Zipper
- » Standing collar
- » ESD logo on sleeve
- » 2 side pockets
- » Not waterproof, for indoor use

STANDARD FABRICS AND COLORS

FOR COLORED INSERTS

FL1 FABRIC



FL1 FABRIC



You can contact us too for customized embroidered or screen printed company logos, lettering, custom designed ESD clothing.



ORDERING CODE SAMPLE

FBF - **FL1** - **NB** / **O** **L**
 style fabric color colored insert size

VIDEO / WEBPAGE



DETAILS ON PAGE 112

SIZE CHART (CM)	XS	S	M	L	XL	XXL	3XL	4XL	5XL
Chest	102	106	110	114	118	122	126	130	134
Length	62	65	68	71	74	77	80	83	83
Sleeve	55	57	59	61	63	65	67	67	68
Shoulder	42	43	44	45	46	47	48	49	49

Size tolerance (before washing): 2%



Clothing certified according to the international ESD standards, as indicated by this/similar label

FSU ESD FLEECE CARDIGAN



LONG ZIPPER

FEATURES

- » Standard sizes: Unisex XS – 5XL
- » Standing collar
- » ESD logo on sleeve
- » 2 side pockets, 1 breast pocket for identity card
- » Not waterproof, for indoor use

STANDARD FABRIC AND COLORS

FL1 FABRIC



You can contact us too for customized embroidered or screen printed company logos, lettering, custom designed ESD clothing.

VIDEO / WEBPAGE



ORDERING CODE SAMPLE

FSU - **FL1** - **DG** **L**
 style fabric color size

Clothing certified according to the international ESD standards, as indicated by this/similar label



DETAILS ON PAGE 112

SIZE CHART (CM)	XS	S	M	L	XL	XXL	3XL	4XL	5XL
Chest	102	106	110	114	118	122	126	130	134
Length	65	68	71	74	77	80	83	86	89
Sleeve	55	57	59	61	63	65	67	67	68
Shoulder	42	43	44	45	46	47	48	49	49

Size tolerance (before washing): 2%

FFF ESD FEMALE FLEECE CARDIGAN

LONG ZIPPER 

FEATURES

- » Standard sizes: Female XS – 5XL
- » Standing collar
- » ESD logo on sleeve
- » 2 side pockets, 1 breast pocket for identity card
- » Not waterproof, for indoor use

STANDARD FABRIC AND COLORS

FL1 FABRIC 



You can contact us too for customized embroidered or screen printed company logos, lettering, custom designed ESD clothing. 

ORDERING CODE SAMPLE

FFF - **FL1** - **O** **L**
 style fabric color size

VIDEO / WEBPAGE 



DETAILS ON PAGE 112

SIZE CHART (CM)	XS	S	M	L	XL	XXL	3XL	4XL	5XL
Chest	102	106	110	114	118	122	126	130	134
Length	62	65	68	71	74	77	80	83	83
Sleeve	55	57	59	61	63	65	67	67	68
Shoulder	42	43	44	45	46	47	48	49	49

Size tolerance (before washing): 2%



Clothing certified according to the international ESD standards, as indicated by this/similar label

WJ ESD WINTER JACKET



STANDING COLLAR

FEATURES

- » Standard sizes: Unisex XS - 5XL
- » Fleece lining
- » Water-repellent outer layer
- » ESD logo on the chest area
- » 2 side pockets
- » Hidden zipper

STANDARD FABRIC AND COLOR

WC10 FABRIC

NB



You can contact us too for customized embroidered or screen printed company logos, lettering, custom designed ESD clothing.

DEMO VIDEO



ORDERING CODE SAMPLE

WJ - **WC10** - **NB** **L**
 style fabric color size

Clothing certified according to the international ESD standards, as indicated by this/similar label



DETAILS ON PAGE 112

SIZE CHART (CM)	XS	S	M	L	XL	XXL	3XL	4XL	5XL
Chest	124	128	132	136	140	144	148	152	156
Sleeve	62	63	64	65	68	68	69	69	70
Length	78	79	80	81	82	83	84	85	86

Size tolerance (before washing): 2%

WW ESD WINTER VEST

STANDING COLLAR 

FEATURES

- » Standard sizes: Unisex XS - 5XL
- » Fleece lining
- » Water-repellent outer layer
- » ESD logo on the chest area
- » 2 side pockets
- » Hidden zipper

STANDARD FABRIC AND COLOR

WC10 FABRIC 

NB

You can contact us too for customized embroidered or screen printed company logos, lettering, custom designed ESD clothing.



ORDERING CODE SAMPLE

WW - **WC10** - **NB** **L**
 style fabric color size

DEMO VIDEO 



DETAILS ON PAGE 113

SIZE CHART (CM)	XS	S	M	L	XL	XXL	3XL	4XL	5XL
Chest	130	132	136	140	144	150	154	158	162
Length	70	71	72	73	74	75	76	77	78

Size tolerance (before washing): 2%



Clothing certified according to the international ESD standards, as indicated by this/similar label

WN ESD WINTER TROUSERS WITH BRIDLES



FEATURES

- » Standard sizes: Unisex XS - 5XL
- » Fleece lining
- » Water-repellent outer layer
- » 2 side pockets, 1 front pocket with ESD logo
- » 2 side pockets on legs
- » 2 quick release buckles

STANDARD FABRIC AND COLOR

WC10 FABRIC

NB



You can contact us too for customized embroidered or screen printed company logos, lettering, custom designed ESD clothing.

DEMO VIDEO



ORDERING CODE SAMPLE

WN - **WC10** - **NB** **L**
 style fabric color size

Clothing certified according to the international ESD standards, as indicated by this/similar label



DETAILS ON PAGE 113

SIZE CHART (CM)	XS	S	M	L	XL	XXL	3XL	4XL	5XL
Length external	104	106	108	110	112	114	116	118	119
Hip	102	107	111	115	119	123	128	132	136
Bridle length	62	63	64	64	66	66	68	68	70

Size tolerance (before washing): 2%



WH ESD WINTER HAT



FEATURES

- » Standard sizes: Unisex, one size
- » With ESD logo
- » Comfortable
- » Warm and breathable

STANDARD FABRICS AND COLORS

PS21 FABRIC				eco EECO-PS21 FABRIC				FL1 FABRIC					
BK	NB	RB	PR	OEKO TEX®	BK	NB	RB	PR	BK	NB	DG	O	Y
DG	GA	W											



You can contact us too for customized embroidered or screen printed company logos, lettering, custom designed ESD clothing.

ORDERING CODE SAMPLE

WH - **PS21** - **NB**
style fabric color

DEMO VIDEO



Clothing certified according to the international ESD standards, as indicated by this/similar label



WS ESD SCARF

FEATURES

- » Standard sizes: Unisex, one size
- » With ESD logo
- » Comfortable
- » Warm and breathable

STANDARD FABRICS AND COLORS

PS21 FABRIC



eco EECO-PS21 FABRIC



FL1 FABRIC



You can contact us too for customized embroidered or screen printed company logos, lettering, custom designed ESD clothing.



DEMO VIDEO



ORDERING CODE SAMPLE

WS - PS21 - NB
 style fabric color



Economy – products with economy price



Models with **OEKO-TEX® STANDARD 100** certification are also available



Clothing certified according to the international ESD standards, as indicated by this/similar label

UTB ESD UTILITY BAG



DIMENSIONS

- » 220 x 100 x 100 mm

PKTT ESD BOTTLE HOLDER



DIMENSIONS

- » 120 mm diameter
- » 290 mm length

CONTACT US IF YOU HAVE DEMAND FOR CUSTOMIZED ESD CLOTHING, ESD CLOTHING PRODUCT.

BUM ESD BELT BAG



DIMENSIONS

- » **Width:** 240 mm
- » **Height:** 160 mm
- » **Depth:** 25 mm
- » **Upper zipper length:** 180 mm
- » **Lower zipper length:** 160 mm

KV1 ESD ARM COVER



INDICATIVE DIMENSIONS

- » **XS** – 270 mm diameter, 450 mm length
- » **S** – 400 mm diameter, 600 mm length
- » **M** – 500 mm diameter, 600 mm length
- » **L** – 600 mm diameter, 700 mm length

**NH ESD
WASHABLE HAIR NET**



**BPK CAP WITH
BUN HOLDER**



CONTACT US IF YOU HAVE DEMAND FOR CUSTOMIZED
ESD CLOTHING, ESD CLOTHING PRODUCT.

COVER ESD COVER



CURT ESD CURTAIN





CLEANROOM LINE

CLOTHING STYLES



102

COV CLEANROOM COVERALL



103

COVH CLEANROOM COVERALL

WITH HOOD



104

COA CLEANROOM COAT



105

JAC CLEANROOM JACKET
TRU CLEANROOM TROUSERS



106

FCH CLEANROOM FULL COVER HOOD



107

FMS CLEANROOM FACE MASK



108

STG CLEANROOM SHOES
WITH TEXTILE GAITER

COV CLEANROOM COVERALL



FEATURES

- » Standard sizes: 3XS - 4XL
- » Double covered front zipper
- » Adjustable waistband inside
- » Standing collar with snaps
- » Raglan sleeve
- » Conductive elasticated cuffs at the wrist and ankle ends
- » ESD logo on the chest area

OPTIONAL

- + Chest, hip or bottom pockets
- + Card holder, pen holder
- + Company logo

STANDARD FABRIC AND COLORS

CR10 FABRIC

LB

W



Individual custom made ESD clothing is also available

ORDERING CODE SAMPLE

COV - **CR10** - **LB** **L**
 style fabric color size

VIDEO / WEBPAGE



Clothing certified according to the international ESD standards, as indicated by this/similar label



DETAILS ON PAGE 114

SIZE CHART (CM)	3XS	XXS	XS	S	M	L	XL	XXL	3XL	4XL
Chest circumference	113,5	119,0	125,5	131,5	135,5	143,0	151,5	155,0	160,0	166,0
Waist circumference	90,0	93,5	99,0	103,5	109,0	116,5	124,5	133,0	140,0	150,0
Hip circumference	106,0	111,0	114,0	119,0	122,0	128,0	136,0	150,0	155,0	162,0
Back length to the hip	51,0	54,0	55,0	55,5	58,0	60,0	62,0	64,5	70,0	75,0
Side length	99,5	103,0	105,5	107,0	112,0	119,0	124,0	127,0	135,5	139,0
Inseam length	70,5	73,5	75,0	77,0	79,0	86,0	91,0	94,5	100,0	103,0
Thigh circumference	59,0	61,0	63,0	66,0	70,0	72,0	76,0	79,0	82,0	86,0
Upper arm circumference	39,0	42,0	45,0	49,0	50,0	53,5	56,0	57,0	58,0	60,0
Sleeve length from the neck area	74,0	75,0	76,0	79,0	80,0	82,0	85,0	86,0	88,0	90,0

Size tolerance (before washing): 3%; shrinkage after cleaning: 3-5%

COVH CLEANROOM COVERALL

WITH INTEGRATED HOOD

FEATURES

OPTIONAL

- + Chest, hip or bottom pockets
- + Card holder, pen holder
- + Company logo
- » Standard sizes: 3XS - 4XL
- » Double covered front zipper
- » Adjustable waistband inside
- » Snaps at neck
- » Raglan sleeve
- » Conductive elasticated cuffs at the wrist and ankle ends
- » Open face area
- » Adjustable by snaps at the back of hood
- » Snap-fasteners for face mask
- » ESD logo on the chest area

STANDARD FABRIC AND COLORS

CR10 FABRIC



Individual custom made ESD clothing is also available



ORDERING CODE SAMPLE

COVH - **CR10** - **W L**
 style fabric color size

VIDEO / WEBPAGE



DETAILS ON PAGE 114

SIZE CHART (CM)	3XS	XXS	XS	S	M	L	XL	XXL	3XL	4XL
Chest circumference	113,5	119,0	125,5	131,5	135,5	143,0	151,5	155,0	160,0	166,0
Waist circumference	90,0	93,5	99,0	103,5	109,0	116,5	124,5	133,0	140,0	150,0
Hip circumference	106,0	111,0	114,0	119,0	122,0	128,0	136,0	150,0	155,0	162,0
Back length to the hip	49,0	52,0	53,0	53,5	56,0	58,0	60,0	62,5	68,0	71,0
Side length	99,5	103,0	105,5	107,0	112,0	119,0	124,0	127,0	135,5	143,0
Inseam length	70,5	73,5	75,0	77,0	79,0	86,0	91,0	94,5	100,0	103,0
Thigh circumference	59,0	61,0	63,0	66,0	70,0	72,0	76,0	79,0	82,0	86,0
Forehead circumference	60,0	60,0	60,0	61,0	63,0	65,0	68,0	71,0	74,0	77,0
Face opening circumference	76,0	77,0	78,0	80,0	82,0	84,0	86,0	88,0	90,0	92,0

Size tolerance (Before washing): 3%; shrinkage by decontamination: 3-5%



Clothing certified according to the international ESD standards, as indicated by this/similar label

COA CLEANROOM COAT



FEATURES

- » Standard sizes: 3XS-4XL
- » Double covered front zipper
- » Standing collar with snaps
- » Raglan sleeve
- » Conductive elasticated cuffs at the wrist ends
- » Extra long coat
- » ESD logo on the chest area

OPTIONAL

- + Chest, hip or bottom pockets
- + Adjustable waistband inside
- + Card holder, pen holder
- + Company logo

STANDARD FABRIC AND COLORS

CR10 FABRIC

LB

W



Individual custom made ESD clothing is also available

ORDERING CODE SAMPLE

COA - **CR10** - **LB L**
 style fabric color size

VIDEO / WEBPAGE



Clothing certified according to the international ESD standards, as indicated by this/similar label



DETAILS ON PAGE 114

SIZE CHART (CM)	3XS	XXS	XS	S	M	L	XL	XXL	3XL	4XL
Chest circumference	113,5	119,0	125,5	131,5	135,5	143,0	151,5	155,0	160,0	166,0
Waist circumference	105,5	109,0	115,0	117,0	126,0	131,5	138,0	143,5	150,0	160,0
Hip circumference	113,0	117,0	121,0	123,5	131,0	140,5	145,5	150,0	155,0	162,0
Back length	109,0	111,0	113,0	114,5	119,0	124,0	125,5	125,5	125,5	125,5
Neck circumference	39,0	40,5	41,5	43,0	44,0	45,5	51,0	52,0	54,0	55,0
Upper arm circumference	41,0	44,0	46,5	49,0	50,5	53,0	56,0	57,0	58,5	61,5
Sleeve length from the neck area	73,0	75,0	77,0	80,0	82,5	83,5	86,0	87,5	88,0	90,5

Size tolerance (Before washing): 3%; shrinkage by decontamination: 3-5%

JAC CLEANROOM JACKET AND TRU CLEANROOM TROUSERS

JACKET FEATURES

- » Standard sizes: 3XS-4XL
- » Front zipper
- » Standing collar with snaps
- » Raglan sleeve
- » Conductive elasticated cuffs at the wrist ends
- » ESD logo on the chest area

OPTIONAL

- + Chest, hip or bottom pockets
- + Card holder, pen holder
- + Company logo

ORDERING CODE SAMPLE

JAC - CR10 - W L
 style fabric color size

TROUSERS FEATURES

- » Standard sizes: 3XS-4XL
- » Adjustable waistband
- » Conductive elasticated cuffs at the ankle ends
- » With ESD logo

OPTIONAL

- + Pockets
- + Company logo

ORDERING CODE SAMPLE

TRU - CR10 - W L
 style fabric color size

STANDARD FABRIC AND COLORS

CR10 FABRIC



DETAILS ON PAGE 115

Size charts (cm)

JAC CLEANROOM JACKET	3XS	XXS	XS	S	M	L	XL	XXL	3XL	4XL
Chest circumference	106,0	109,0	112,0	116,0	124,0	131,0	136,0	141,0	146,0	154,0
Waist circumference	99,0	102,0	105,0	109,0	117,0	124,0	129,0	134,0	139,0	147,0
Hip circumference	115,0	118,0	121,0	125,0	133,0	140,0	145,0	150,0	155,0	163,0
Back length	73,5	75,5	78,5	81,5	85,5	88,0	90,0	92,5	94,0	94,0
Neck circumference	45,0	46,5	47,5	48,0	50,0	55,0	57,0	59,0	59,0	59,0
TRU CLEANROOM TROUSERS	3XS	XXS	XS	S	M	L	XL	XXL	3XL	4XL
Waist circumference (Contracted)	75,0	78,0	80,0	83,0	87,0	90,0	99,0	103,0	107,0	114,0
Waist circumference (Expanded)	98,0	102,0	104,0	108,0	113,0	116,0	128,0	133,0	138,0	146,0
Crotch circumference	108,0	111,0	114,0	118,0	120,0	123,0	133,0	138,0	143,0	149,0
Trousers length	103,0	105,0	107,0	110,5	113,0	116,0	121,0	125,0	127,0	131,0
Inseam	74,0	75,5	78,0	80,0	82,0	84,5	88,0	90,0	92,0	94,0
Thigh circumference	58,0	59,0	61,0	62,0	63,0	66,0	71,0	74,0	78,0	82,0

Size tolerance (Before washing): 3%; shrinkage by decontamination: 3-5%

VIDEO / WEBPAGE



Clothing certified according to the international ESD standards, as indicated by this/similar label



Individual custom made ESD clothing is also available

FCH CLEANROOM FULL COVER HOOD



FEATURES

- » Standard sizes: XXS-XXL
- » Front zipper
- » Flat top
- » Adjustable by snaps behind
- » Open face
- » Snap-fasteners for face mask
- » With ESD logo

STANDARD FABRIC AND COLORS

CR10 FABRIC

LB

W



Individual custom made ESD clothing is also available

ORDERING CODE SAMPLE

FCH - **CR10** - **LB L**
 style fabric color size

OPTIONAL

- + Company logo

VIDEO / WEBPAGE



Clothing certified according to the international ESD standards, as indicated by this/similar label



DETAILS ON PAGE 115

SIZE CHART (CM)	XXS	XS	S	M	L	XL	XXL
E	23,5	24,5	26,0	26,0	28,5	28,5	28,5
H	13,0	14,0	15,0	16,0	17,0	17,0	17,0
A1	52,0	55,0	58,0	61,0	63,5	66,0	69,0
G	6,0	6,0	6,0	6,0	6,5	6,5	6,5
S	21,0	21,0	21,0	21,0	21,0	21,0	21,0

Size tolerance (Before washing): 3%; shrinkage by decontamination: 3-5%

FMS CLEANROOM FACE MASK

FEATURES

- » One size
- » With snaps that can be attached to a hood
- » For COVH or FCH products, not usable on its own.

STANDARD FABRIC AND COLORS

CR10 FABRIC

LB

W

Individual custom made ESD clothing is also available



VIDEO / WEBPAGE



ORDERING CODE SAMPLE

FMS - **CR10** - **W**
 style fabric color



DETAILS ON PAGE 115

SIZE CHART (CM)	Size
A	25,0
B	6,0
C	31,0
D	30,0

Size tolerance (Before washing): 3%; shrinkage by decontamination: 3-5%

STG CLEANROOM SHOES

WITH TEXTILE GAITER

FEATURES

- » Front zipper
- » Comfortable shoes
- » Conductive soles
- » Adjustable ribbon with velcro
- » With ESD logo

STANDARD FABRIC AND COLOR

CR10 FABRIC

W



Individual custom made ESD clothing is also available

ORDERING CODE SAMPLE

STG - **CR10** - **W** **41**
style fabric color size

VIDEO / WEBPAGE



STANDARD SIZES

35 35,5 36,5 37 38 38,5 39,5 40 41 41,5 42,5 43 44 45,5 47

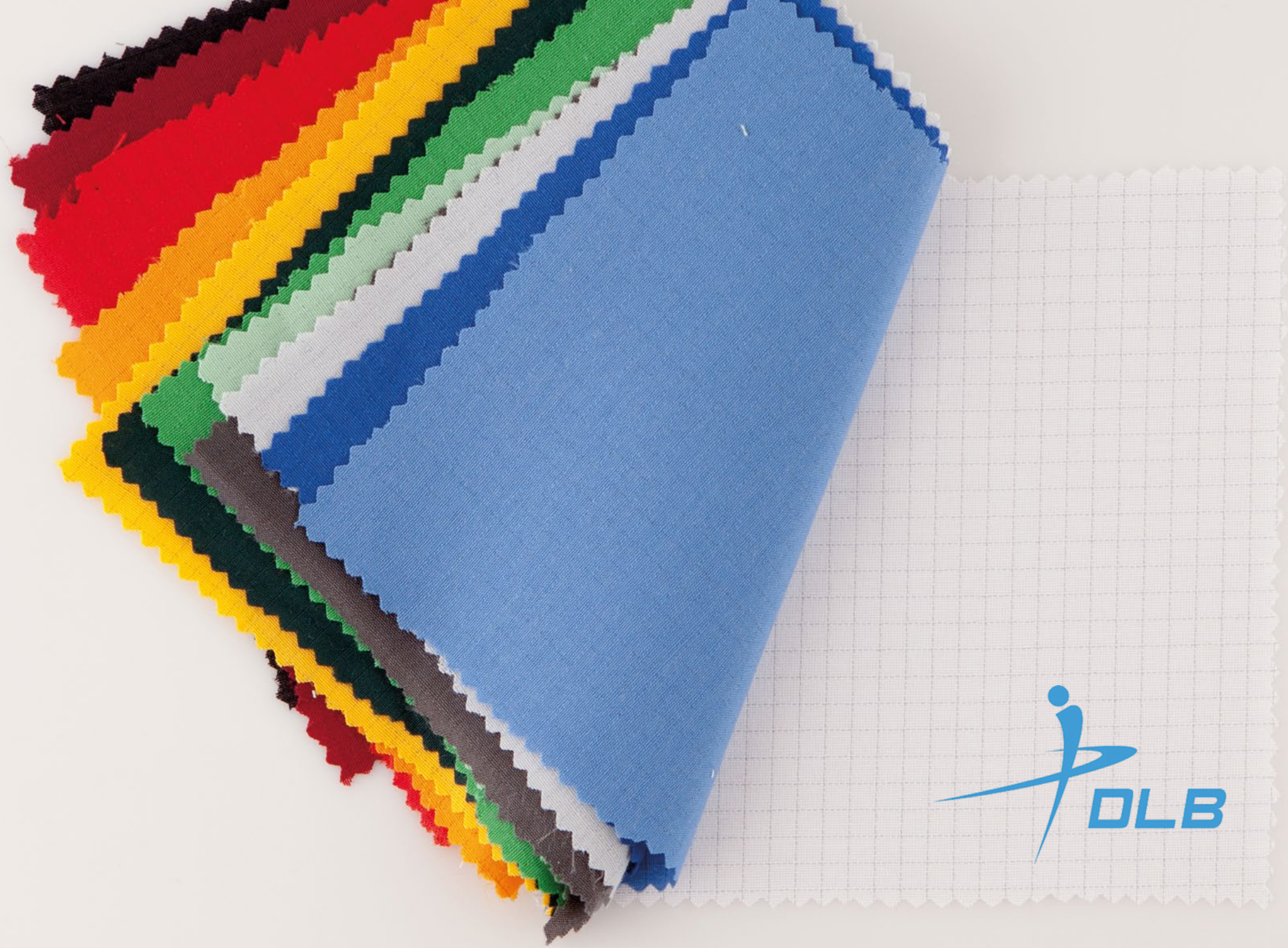

PGO/F PGZ/F TGO/F TGZ/F
TKO/F TKZ/F TLY

○ **DESCRIPTION**

1. Sleeve
2. Chest
3. Length
4. Shoulder

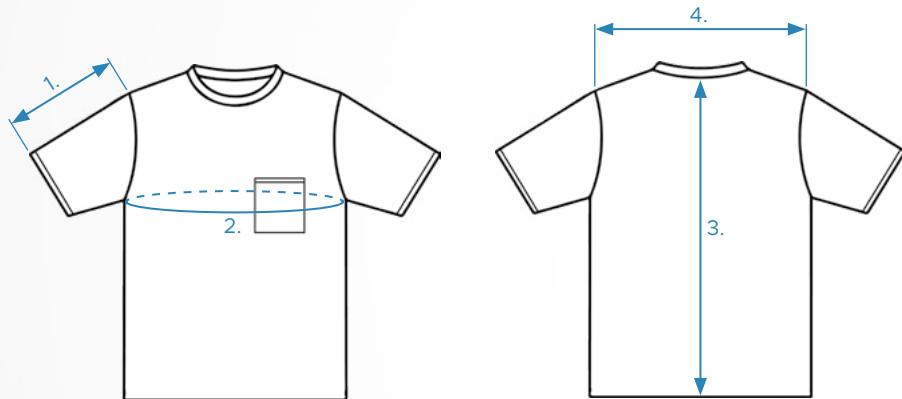

ING IFG LGO/F LGZ/F LKO/F LKZ/F
QGO/F QGZ/F SKS WJ FCU
FCF FBU FBF FSU FFF

○ **DESCRIPTION**

1. Sleeve
2. Chest
3. Length
4. Shoulder
5. Cuff

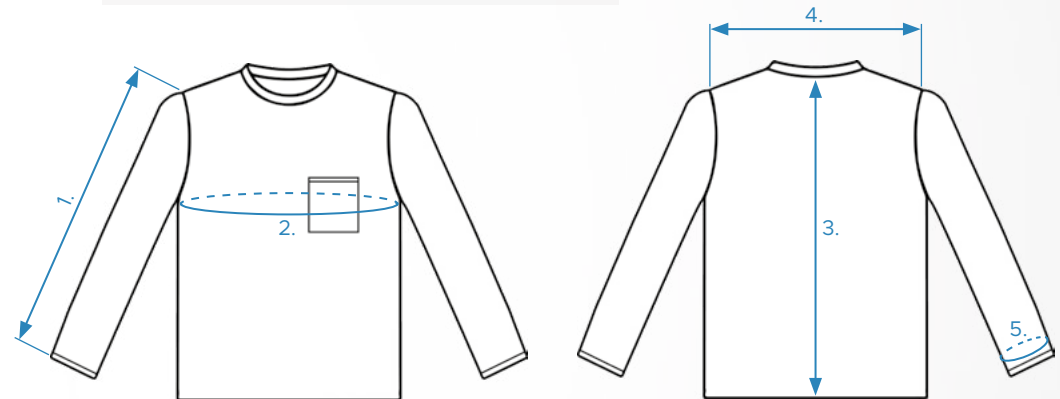

○ **SIZE CHART FOR FEMALE SHORT SLEEVE T-SHIRTS AND POLO-SHIRTS**

PGOF PGZF TGOF TGZF TKOF TKZF

SIZE CHART (CM)	XS	S	M	L	XL	XXL	3XL	4XL	5XL
Sleeve	20,5	21,5	22,5	23,5	25	26,5	28	29,5	31
Length	63	66	69	72	75	78	81	84	87
Chest	82	86	91	96	102	110	114	118	122
Waist	66	70	75	80	86	94	98	104	108
Hip	90	94	99	105	111	117	123	129	135
Shoulder	39	40	41	42	43	44	45	46	47

Size tolerance (before washing): 2%

○ **SIZE CHART FOR FEMALE LONG SLEEVE T-SHIRTS AND POLO-SHIRTS**

LGOF LGZF LKOF LKZF QGOF QGZF

SIZE CHART (CM)	XS	S	M	L	XL	XXL	3XL	4XL	5XL
Sleeve	51,5	53	57	61	63	65	67	67	68
Length	63	66	69	72	75	78	81	84	87
Chest	82	86	91	96	102	110	114	118	122
Waist	66	70	75	80	86	94	98	104	108
Hip	90	94	99	105	111	117	123	129	135
Shoulder	39	40	41	42	43	44	45	46	47

Size tolerance (before washing): 2%

EFL EFS EFX ESL ESS ESX OJ
PF1 PS1 PF2 PS2 PF3 PS3

DESCRIPTION

- 1. Chest
- 2. Shoulder
- 3. Sleeve
- 4. Length
- 5. Cuff
- 6. Hip

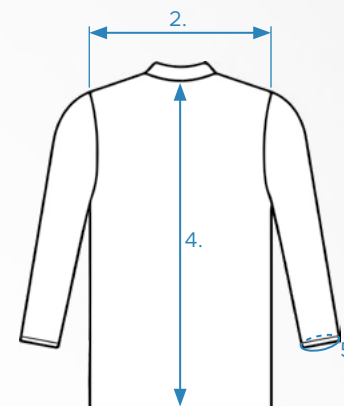
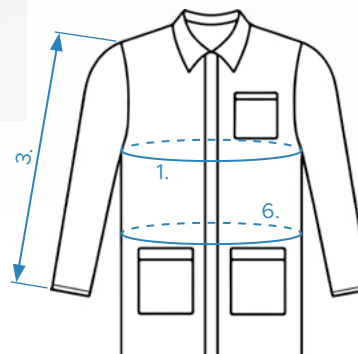

HIV SGW SWW SWW-Z
VES-H VES-S VES-T WW

DESCRIPTION

- 1. Chest
- 2. Length (length at the back in the case of VES-T)
- 3. Shoulder

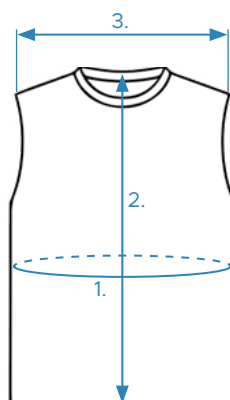

CAS CAL CAL-H
SWS SGS

DESCRIPTION

- 1. Sleeve
- 2. Chest
- 3. Length
- 4. Shoulder
- 5. Cuff

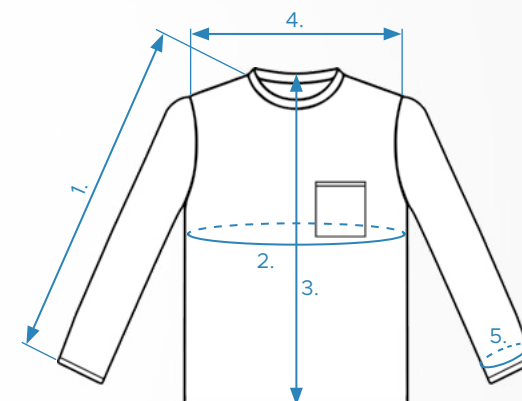

ET ETF NT NTF
OT RGA WN

DESCRIPTION

- 1. Hip
- 2. Length external

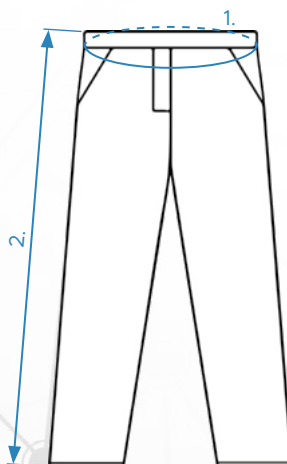

SKI

DESCRIPTION

- 1. Waist
- 2. Hip
- 3. Length

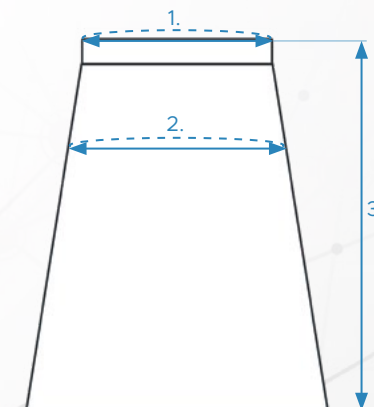

COV COVH

○ **DESCRIPTION**

- 1. Chest circumference
- 2. Waist circumference
- 3. Hip circumference
- 4. Back length to the hip
- 5. Side length
- 6. Inseam length
- 7. Thigh circumference
- 8. Upper arm circumference
- 9. Sleeve length from the neck area
- 10. Forehead circumference
- 11. Face opening circumference

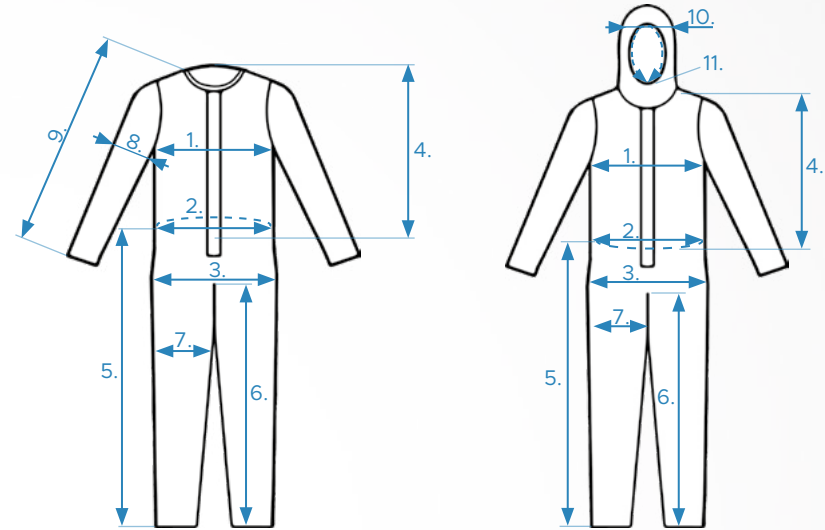

COA

○ **DESCRIPTION**

- 1. Chest circumference
- 2. Waist circumference
- 3. Hip circumference
- 4. Back length
- 5. Neck circumference
- 6. Upper arm circumference
- 7. Sleeve length from the neck area

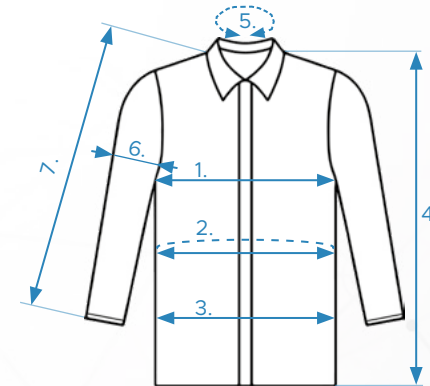

JAC

○ **DESCRIPTION**

- 1. Chest circumference
- 2. Waist circumference
- 3. Hip circumference
- 4. Back length
- 5. Neck circumference

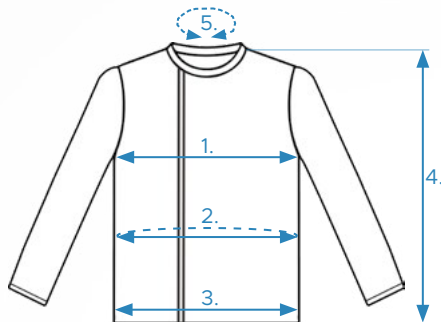

TRU

○ **DESCRIPTION**

- 1. Waist circumference (Contracted)
- 2. Waist circumference (Expanded)
- 3. Crotch circumference
- 4. Trousers length
- 5. Inseam
- 6. Thigh circumference

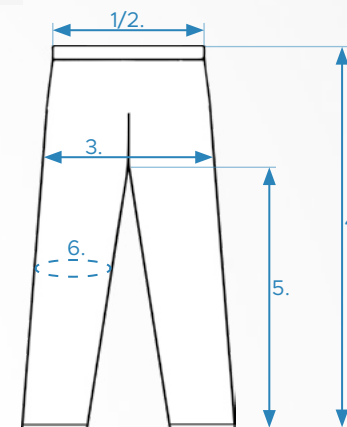

FCH

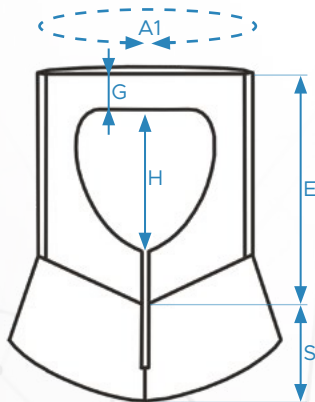

FMS

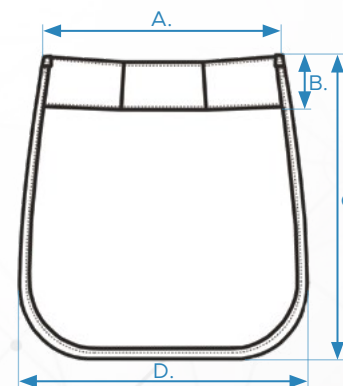



LOGO DESIGN

Upon request, we can customize your clothing with your company logo or a personalized inscription.

Please send your logo in *.jpg format via e-mail, we will prepare our offer to you.



[SCAN ME]

and download
our latest
garments
catalogue



D és Tsa Bt.

Office and Warehouse:
2600 Vác, Galcsek u. 8-10.

Phone: +36 27 502 555

Email: sales@destsa.hu

Web: www.dlb.hu

